



TPCODL/P&S/1000000082/2021-22

TP CENTRAL ODISHA DISTRIBUTION LIMITED
(A Tata Power & Odisha Govt. joint venture)
2nd Floor, IDCO Tower, Janpath, Bhubaneswar, Odisha 751022

OPEN TENDER NOTIFICATION

FOR

RATE CONTRACT FOR SUPPLY OF V-CROSS ARM 11kV and 33kV

Tender Enquiry No.: TPCODL/P&S/1000000082/2021-22

Due Date for Bid Submission: 10th August-2021 [17:00 Hrs.]

**TP Central Odisha Distribution Limited
(A TATA Power and Odisha Government Joint Venture)
Procurement & Stores Department,
2nd Floor, IDCO Towers, Janpath, Bhubaneswar – 751022**

TP CENTRAL ODISHA DISTRIBUTION LIMITED

(A Tata Power & Odisha Govt. joint venture)

2nd Floor, IDCO Tower, Janpath, Bhubaneshwar, Odisha 751022

Procedure to Participate in E-Tender**Tender Enquiry No- TPCODL/P&S/100000081/2021-22**

Tender Enquiry No	Work Description	EMD (Rs.)	Tender Participation Fee (Rs.)	Last Date and Time for payment of Tender Participation Fee
TPCODL/P&S/100000082/2021-22	OPEN TENDER NOTIFICATION FOR SUPPLY OF V-Cross Arm (11kV and 33kV)	1,00,000/-	5,000/-	24/07/2021, 17.00 Hrs

Step 1: The bidder can get primary information about the tender from the NEWSPAPER advertisement / TPCODL website (in case of open tender) / invitation through e-mail (in case of limited tenders).

Step 2: First the prospective Bidder who intends to participate in an open tender should deposit the requisite tender fee as mentioned in the tender document through NEFT/ RTGS in the a/c of TPCODL as mentioned in the tender document. Deposit of the Tender fee should be made within the scheduled time for such deposit as indicated in the Tender document.

Step 3: After deposit of the tender fee, the bidder should furnish the following information through e-mail to the contact person indicated in the tender document.

Please note that corresponding details mentioned in this document will supersede any other details mentioned anywhere else in the Tender Document.

Procedure to Participate in Tender.

Following steps to be done before “Last date and time for Payment of Tender Participation Fee” as mentioned above

1. Eligible and Interested Bidders to submit duly signed and stamped letter on Bidder's letter head indicating
 - a. Tender Enquiry number
 - b. Name of authorized person ,Address,Postal code (pin code)
 - c. Contact number
 - d. e-mail id
 - e. Details of submission of Tender Participation Fee (bank name/amount/NEFT-RTGS UTR No.
 - f. GST Registration No
2. Non-Refundable Tender Participation Fee, as indicated in table above, to be submitted in the form of Direct deposit in the following bank account and submit the receipt along with a covering letter clearly indicating the Tender Reference/ Enquiry Number –

Beneficiary Name – TP Central Odisha Distribution Ltd.

Bank Name – STATE BANK OF INDIA

Branch Name – IDCO Towers, Bhubaneshwar

Address – PO- Sahidnagar, Janapath, Bhubaneswar.

TP CENTRAL ODISHA DISTRIBUTION LIMITED
(A Tata Power & Odisha Govt. joint venture)
2nd Floor, IDCO Tower, Janpath, Bhubaneswar, Odisha 751022

Branch Code – 7891

Account No – 10835304915

IFSC Code – SBIN0007891

Step 4: After receipt of the above information through e-mail, Vendor will get an **invitation email** from ARIBA System which is the e-tendering platform of TPCODL. In this mail there will be an online link as **Click Here** to participate in the tender.

Step 5: Click "**Click Here**" to access this event.

Step 6: If you are bidding first time for TPCODL through ARIBA site then please "Sign UP by creating User Name and password as mentioned in Sign Up page. Please follow the process, as mentioned in the Sign Up page, during creation of User Name and password.

Those who are already having User Name and password for accessing TPCODL events, they can LOGIN using same User Name and password.

Step 7: Click Continue. The simple one-page registration screen will open for first time user. All * mark mandatory field to be filled in.

Step 8: You will be able to see the RFQ (i.e Detail Tender document).

Step 9: After review and downloading of all documents click on "**Accept Review Prerequisites**" i.e acceptance of terms and conditions.

Step 10: Review and accept "**Bidder Agreement**".

Step 11: You can see attached tender document in PDF format against clause no 1.1.1 (Introduction).

Step 12: Vendor has to attach PDF version of technical bid in clause no. 2.1 and 2.2. (**In this field do not attach any price document.**)

Step 13: Uploading of Price Bid

(a) Price schedule is attached in envelope.3.1 of ARIBA. Same has to be downloaded and price and tax details to be filled in as per the format given, print to be taken in vendor's letter head and signature and seal to be made by authorised person. PDF version of this price bid to be attached. For Price Bid put all the unit price and taxes and duties in provided field. Put "0" (ZERO) in not applicable field.

(b) In addition, the bidder has to upload the editable form of the price bid in EXCEL format in envelope 3.2 of ARIBA system.

Step 14: After uploading successfully Techno commercial offer and price part then click on "**Submit Entire Response**".

Note: Once user ID and password created, bidder can also login to ARIBA site through the following URL:

<https://service.ariba.com/Sourcing.aw/124997008/aw?awh=r&awssk=oxt0s1BN&dard=1>

CONTENTS OF THE ENQUIRY

Contents

1.0	Event Information	5
2.0	Evaluation Criteria	7
3.0	Submission of Bid Documents	7
4	Bid Opening & Evaluation process	11
5	Award Decision	12
6	Order of Preference/Contradiction	12
7	Post Award Contract Administration.....	12
8	Specification and standards	14
9	General Condition of Contract	14
10	Safety	14
	ANNEXURE I.....	15
	ANNEXURE II.....	16
	ANNEXURE III	44
	ANNEXURE IV	45
	ANNEXURE V	46
	ANNEXURE VI	47
	ANNEXURE VII	48
	ANNEXURE VIII.....	49
	ANNEXURE IX	95
	ANNEXURE X	107
	ANNEXURE XI	108

TP CENTRAL ODISHA DISTRIBUTION LIMITED

(A Tata Power & Odisha Govt. joint venture)

2nd Floor, IDCO Tower, Janpath, Bhubaneswar, Odisha 751022

1.0 Event Information
1.1. Scope of work

Open Tenders are invited from interested Bidders entering into a Rate Contract valid for 1 years for the following:

S. No.	Description	EMD Amount (Rs.)	Tender Fee* (Rs.)
1.	OPEN TENDER NOTIFICATION FOR SUPPLY OF V-Cross Arm (11kV and 33kV)	1,00,000/-	5,000/-

**inclusive of GST*

1.2. Availability of Tender Documents

Non-transferable tender documents may be purchased by interested eligible bidders from address given below, on submission of written application to the under mentioned and upon payment of non-refundable Tender Fee.

Chief (Procurement & Stores)

TP Central Odisha Distribution Limited

 2nd Floor, IDCO Towers, Janpath, Bhubaneswar – 751022

Tender documents may be downloaded by interested eligible bidders from TPCODL website www.tpcentralodisha.com with effect from 18th Dec 2020. In the event of detailed tender documents are downloaded from TPCODL website, the Tender Fee shall be compulsorily submitted either online through NEFT/ RTGS or demand draft/ Banker's Cheque drawn in favor of "TP Central Odisha Distribution Limited", payable at Bhubaneswar only. Any such bid submitted without this Fee shall be rejected.

Bidders are requested to visit TPCODL website www.tpcentralodisha.com regularly for any modification/ clarification to the bid documents.

1.3. Calendar of Events

(a)	Date of sale/ availability of tender documents from TPCODL Website	15.07.2021 1000 Hours
(b)	Last date and time of Payment of Tender Fee	24.07.2021 1700 Hours
(c)	Last Date of receipt of pre-bid queries, if any	28.07.2021 1000 Hours
(d)	Last Date of Posting Consolidated replies to all the pre-bid queries as received	04.08.2021 1800 Hours
(e)	Last date and time of receipt of Bids	10.08.2021 1700 Hours
(f)	Date & Time of opening technical bids and EMD (Envelope-1 & 2)	10.08.2021 1700 Hours

Note: In the event of last date specified for submission of bids and date of opening of bids is declared as a closed holiday for TPCODL's office, the last date of submission of bids and date of opening of bids will be the day following working day at appointed times.

1.4 Mandatory documents required along with the Bid

TP CENTRAL ODISHA DISTRIBUTION LIMITED

(A Tata Power & Odisha Govt. joint venture)

2nd Floor, IDCO Tower, Janpath, Bhubaneswar, Odisha 751022

- 1.4.1 EMD of requisite value and validity
- 1.4.2 Tender Fee in case the tender is downloaded from website
- 1.4.3 Requisite Documents for compliance to Qualification Criteria mentioned in Clause 1.7.
- 1.4.4 Drawing, Type Test details along with a sample of each item as specified at Annexure I (as applicable)
- 1.4.5 Duly signed and stamped 'Schedule of Deviations' as per Annexure III on bidder's letter head.
- 1.4.6 Duly signed and stamped 'Schedule of Commercial Specifications' as per Annexure IV on bidder's letter head.
- 1.4.7 Proper authorization letter/ Power of Attorney to sign the tender on the behalf of bidder.
- 1.4.8 Copy of PAN, GST, PF and ESI Registration (In case any of these documents is not available with the bidder, same to be explicitly mentioned in the 'Schedule of Deviations')

Please note that in absence of any of the above documents, the bid submitted by a bidder shall be liable for rejection.

1.5. Deviation from Tender

Normally, the deviations to tender terms are not admissible and the bids with deviation are liable for rejection. Hence, the bidders are advised to refrain from taking any deviations on this Tender. Still in case of any deviations, all such deviations shall be set out by the Bidders, clause by clause in the 'Annexure III - Schedule of Deviations' and same shall be submitted as a part of the Technical Bid.

1.6. Right of Acceptance/Rejection

Bids are liable for rejection in absence of following documents:

- i. EMD of requisite value and validity
- ii. Tender fee of requisite value
- iii. Price Bid as per the Price Schedule mentioned in Annexure I (BOQ)
- iv. Necessary documents against compliance to Qualification Requirements mentioned at Clause 1.7 of this Tender Document
- v. Filled in Schedule of Deviations as per Annexure III
- vi. Filled in Schedule of Commercial Specifications as per Annexure IV
- vii. Receipt of Bid within the due date and time

TPCODL reserves the right to accept/reject any or all the bids without assigning any reason thereof.

1.7 Qualification Criteria

- a) The average annual turnover of the bidder shall be a minimum of Rs. 2.0 Crs for last three financial years. (FY 17-18, FY 18-19, FY 19-20) Copy of audited Balance Sheet and P&L Account to be submitted in this regard.
- b) Bidder should have a valid Manufacturing license issued by concerned state/India Govt. for carrying out these works, the copies of such License to be provided
- c) In case of supplier/traders (not having manufacturing facility of their own) shall be consider eligible provided they
 - (a) submit an undertaking to facilitate testing for offered material in an accredited laboratory.
 - (b) Provide a valid authorization from concerned manufacturer for dealing with offered material.
- d) Bidder must have successfully executed the supply of V-Cross Arm 11kV for a minimum 1000 Qty. or more in single order or 300 qty in 3 orders. V-Cross Arm 33 kV for a minimum 1000 Qty. or more in single order or 300 qty in 3 orders. Top Hamper 33 kV Cross Arm for a minimum 1000 Qty. or more in single order or 300 qty in 3 orders. Top Hamper 11 kV Cross Arm for a minimum 1000 Qty. or more in single order or 300 qty in 3 orders.

TP CENTRAL ODISHA DISTRIBUTION LIMITED

(A Tata Power & Odisha Govt. joint venture)

2nd Floor, IDCO Tower, Janpath, Bhubaneswar, Odisha 751022

within last 5 Year. Copy of completion certificates to be submitted in this regard.

e) Bidder must have all statutory compliance like valid PAN, ESI registration, EPF registration and GSTN registration

1.8. Marketing Integrity

We have a fair and competitive marketplace. The rules for bidders are outlined in the General Condition of Contracts. Bidders must agree to these rules prior to participating. In addition to other remedies available, TPCODL reserves the right to exclude a bidder from participating in future markets due to the bidder's violation of any of the rules or obligations contained in the General Condition of Contracts. A bidder who violates the market place rules or engages in behavior that disrupts the fair execution of the marketplace, may result in restriction of a bidder from further participation in the marketplace for a length of time, depending upon the seriousness of the violation. Examples of violations include, but are not limited to:

- Failure to honor prices submitted to the marketplace
- Breach of terms as published in TENDER/NIT

1.9. Supplier Confidentiality

All information contained in this tender is confidential and shall not be disclosed, published or advertised in any manner without written authorization from TPCODL. This includes all bidding information submitted to TPCODL. All tender documents remain the property of TPCODL and all suppliers are required to return these documents to TPCODL upon request. Suppliers who do not honor these confidentiality provisions will be excluded from participating in future bidding events.

2.0 Evaluation Criteria

- The bids will be evaluated technically on the compliance to tender terms and conditions.
- The bids will be evaluated commercially on over BOQ basis (all-inclusive lowest cost) for the complete tender as calculated in Schedule of Items [Annexure I].
- The bids will be evaluated on Safety Parameters as mentioned in Annexure-VIII. Bidders have to submit all the documents related to safety bid.
- Bidder has to mandatorily quote against each item of Schedule of Items [Annexure I]. Failing to do so, TPCODL may reject the bids.

NOTE: In case a new bidder is not registered with TPCODL, factory inspection and evaluation shall be carried out to ascertain bidder's manufacturing capability and quality procedures. However, TPCODL reserves the right to carry out factory inspection and evaluation for any bidder prior to technical qualification.

In case a bidder is found as Disqualified in the factory evaluation, their bid shall not be evaluated any further and shall be summarily rejected. The decision of TPCODL shall be final and binding on the bidder in this regard.

2.1 Price Variation Clause: The prices shall remain firm during the entire contract period.

3.0 Submission of Bid Documents**3.1 Bid Submission**

Bidders are requested to submit their offer in line with this Tender document through e-tendering process.

Please note all future correspondence regarding the tender, bid submission, bid submission date extension, Pre-bid query etc. will happen only through TPCODL E-Tender system (Ariba).

No e-mail or verbal correspondence will be responded. All communication will be done strictly with the bidder who have done the above step to participate in the Tender.

TP CENTRAL ODISHA DISTRIBUTION LIMITED

(A Tata Power & Odisha Govt. joint venture)

2nd Floor, IDCO Tower, Janpath, Bhubaneswar, Odisha 751022

Bids shall be submitted in 4 (four) parts:

FIRST PART: “EMD” as applicable shall be submitted. The EMD shall be valid for 210 days from the due date of bid submission in the form of Bank Guarantee / Bank Draft / Bankers Pay Order (issued from a Scheduled Bank) online NEFT/ RTGS transfer favoring ‘TP Central Odisha Distribution Limited’ payable at Bhubaneswar. The EMD has to be strictly in the format as mentioned in General Condition of Contract, failing which it shall not be accepted by TPCODL and the bid as submitted shall be liable for rejection. A separate non-refundable tender fee of stipulated amount also needs to be transferred online through NEFT/ RTGS in case the tender document is downloaded from our website.

TPCODL Bank Details for transferring Tender Fee and EMD is as below:

Account Name: TP CENTRAL ODISHA DISTRIBUTION LIMITED

Bank Name: SBI, IDCO Towers, Bhubaneswar

Bank Account No.: 10835304915

IFSC Code: SBIN0007891

Note- EMD is preferred in form of Bank Guarantee and to be delivered at the following address. However, in view of present situation if Bidder is finding it difficult to make and submit BG for EMD amount, they can do online transfer of EMD amount in the above mentioned Account and submit proof of the same as part of Bid Submission.

Please note that in such case, Tender Fee and EMD should be strictly 2 separate transactions.

Please note as return of EMD from Bank Account is non-standard practice the same may take more time than return of EMD BG.

EMD Original Hard Copy shall be delivered at the following address in Envelope clearly indicating Tender Reference/ Enquiry Number, Name of Tender and Bidder Name

Chief (Procurement & Stores)

TP Central Odisha Distribution Limited

2nd Floor, IDCO Towers, Janpath, Bhubaneswar- 751022

SECOND PART: “TECHNICAL BID” shall contain the following documents:

- a) Documentary evidence in support of qualifying criteria
- b) Technical literature/GTP/Type test report etc. (if applicable)
- c) Qualified manpower (if available)
- d) Testing facilities (if applicable)
- e) No Deviation Certificate as per the Annexure III – Schedule of Deviations
- f) Acceptance to Commercial Terms and Conditions viz. Delivery schedule/period, payment terms etc. as per the Annexure IV – Schedule of Commercial Specifications.
- g) Quality Assurance Plan/Inspection Test Plan for supply items (if applicable)

The technical bid shall be properly indexed and is to be submitted through TPCODL E-tender System (Ariba) only. Hard Copy of Technical Bids need not be submitted.

THIRD PART (Safety Bid): Bidder shall mention the details as required in the safety bid form (As mentioned in annexure- IX). Bidder also has to submit the relevant documents for the same as required by TPCODL

FOURTH PART: “PRICE BID” shall contain only the price details and strictly in format as mentioned in Annexure I along with explicit break up of basic prices, Taxes & duties, Freight etc. In case any discrepancy is observed between the item description stated in Schedule of Items mentioned in the tender and the price bid submitted by the bidder, the item description as mentioned in the tender document (to the extent modified through Corrigendum issued if any) shall prevail.

TP CENTRAL ODISHA DISTRIBUTION LIMITED

(A Tata Power & Odisha Govt. joint venture)

2nd Floor, IDCO Tower, Janpath, Bhubaneswar, Odisha 751022

Price Bid is to be submitted in soft copy through TPCODL E-Tendering system (Ariba) only. Hard copy of Price Bid not be submitted.

The EMD in the form of Bank Draft / BG / Bankers Pay Order shall be submitted in original hard copy and then placed in sealed envelope which shall be clearly marked as below:

EMD

“OPEN TENDER NOTIFICATION FOR SUPPLY OF V-Cross Arm (11kV and 33kV)”

The Bid prepared by the Bidder, and all correspondence and documents relating to the Bid exchanged by the Bidder and the TPCODL, shall be written in the English Language. Any printed literature furnished by the Bidder may be written in another Language, provided that this literature is accompanied by an English translation, in which case, for purposes of interpretation of the Bid, the English translation shall govern.

SIGNING OF BID DOCUMENTS:

The bid must contain the name, residence and place of business of the person or persons making the bid and must be signed and sealed by the Bidder with his usual signature. The names of all persons signing should also be typed or printed below the signature.

The Bid being submitted must be signed by a person holding a Power of Attorney authorizing him to do so, certified copies of which shall be enclosed.

The Bid submitted on behalf of companies registered with the Indian Companies Act, for the time being in force, shall be signed by persons duly authorized to submit the Bid on behalf of the Company and shall be accompanied by certified true copies of the resolutions, extracts of Articles of Association, special or general Power of Attorney etc. to show clearly the title, authority and designation of persons signing the Bid on behalf of the Company. Satisfactory evidence of authority of the person signing on behalf of the Bidder shall be furnished with bid.

A bid by a person who affixes to his signature the word ‘President’, ‘Managing Director’, ‘Secretary’, ‘Agent’ or other designation without disclosing his principal will be rejected.

The Bidder’s name stated on the Proposal shall be the exact legal name of the firm.

3.2 Contact Information

All the bidders are requested to send their pre-bid queries (if any) against this tender through e-mail within the stipulated timelines. The consolidated reply to all the queries received shall be posted on TPCODL website by the stipulated timelines as detailed in calendar of events.

Communication Details:**Handling Team Lead for this Tender:**

Name: Prashant Gupta
Contact No.: 9634077589
E-Mail ID: Prashant.Gupta@tpcentralodisha.com

Senior General Manager (Material Procurement):

Name: Mr. Deba Prasad Das
Contact No.: 9438297571
E-Mail ID: debaprasad.das@tpcentralodisha.com

3.3 Bid Prices

TP CENTRAL ODISHA DISTRIBUTION LIMITED

(A Tata Power & Odisha Govt. joint venture)

2nd Floor, IDCO Tower, Janpath, Bhubaneswar, Odisha 751022

Bidders shall quote for the entire Scope of Supply/ work with a break up of prices for individual items and Taxes & duties. The bidder shall complete the appropriate Price Schedules included herein, stating the Unit Price for each item & total price with taxes, duties & freight up to destination at various sites of TPCODL. The all-inclusive prices offered shall be inclusive of all costs as well as Duties, Taxes and Levies paid or payable during the execution of the supply work, breakup of price constituents.

Applicable GST to be specified clearly.

The quantity break up shown else-where other than Price Schedule is tentative. The bidder shall ascertain himself regarding material required for completeness of the entire work. Any items not indicated in the price schedule but which are required to complete the job as per the Technical Specifications/ Scope of Work/ SLA mentioned in the tender, shall be deemed to be included in prices quoted.

3.4 Bid Currencies

Prices shall be quoted in Indian Rupees Only.

3.5 Period of Validity of Bids

Bids shall remain valid for 180 days from the due date of submission of the bid.

Notwithstanding clause above, the TPCODL may solicit the Bidder's consent to an extension of the Period of Bid Validity. The request and responses thereto shall be made in writing.

RC Validity: - The validity of this rate contract shall be one year from the date of issuance.

3.6 Alternative Bids

Bidders shall submit Bids, which comply with the Bidding documents. Alternative bids will not be considered. The attention of Bidders is drawn to the provisions regarding the rejection of Bids in the terms and conditions, which are not substantially responsive to the requirements of the bidding documents.

3.7 Modifications and Withdrawal of Bids

The bidder is not allowed to modify or withdraw its bid after the Bid's submission. The EMD as submitted along with the bid shall be liable for forfeiture in such event.

3.8 Earnest Money Deposit (EMD)

The bidder shall furnish, as part of its bid, an EMD amounting as specified in the tender. The EMD is required to protect TPCODL against the risk of bidder's conduct which would warrant forfeiture.

The EMD shall be denominated in any of the following form:

- Banker's Cheque/ Demand Draft/ Pay order drawn in favor of TP Central Odisha Distribution Limited payable at Bhubaneswar.
- Online transfer of requisite amount through NEFT/ RTGS.
- Bank Guarantee valid for 210 days after due date of submission.

The EMD shall be forfeited in case:

- a) The bidder withdraws its bid during the period of specified bid validity.

Or

- b) The successful Bidder does not
- a) accept the Purchase Order, or
 - b) furnish the required Performance Security Bank Guarantee

3.9 Type Tests (if applicable)

The type tests specified in TPCODL specifications should have been carried out within five years prior to the date of opening of technical bids and test reports are to be submitted along with the bids. If type tests

TP CENTRAL ODISHA DISTRIBUTION LIMITED

(A Tata Power & Odisha Govt. joint venture)

2nd Floor, IDCO Tower, Janpath, Bhubaneswar, Odisha 751022

carried out are not within the five years prior to the date of bidding, the bidder will arrange to carry out type tests specified, at his cost. The decision to accept/ reject such bids rests with TPCODL.

4 Bid Opening & Evaluation process**4.1. Process to be confidential**

Information relating to the examination, clarification, evaluation and comparison of Bids and recommendations for the award of a contract shall not be disclosed to Bidders or any other persons not officially concerned with such process. Any effort by a Bidder to influence the TPCODL's processing of Bids or award decisions may result in rejection of the Bidder's Bid.

4.2. Technical Bid Opening

Bids will be opened at TPCODL Office, Bhubaneswar. All tender bids shall be opened internally by TPCODL. Presence of any bidder will not be allowed during bid opening process. Technical bid must not contain any cost information whatsoever.

First the envelope marked "EMD" will be opened. Bids without EMD/cost of tender (if applicable) of required amount/ validity in prescribed format, shall be rejected.

Next, the technical bid of the bidders who have furnished the requisite EMD will be opened, one by one.

4.3. Preliminary Examination of Bids/Responsiveness

TPCODL will examine the Bids to determine whether they are complete, whether any computational errors have been made, whether required sureties have been furnished, whether the documents have been properly signed, and whether the Bids are generally in order. TPCODL may ask for submission of original documents in order to verify the documents submitted in support of qualification criteria.

Arithmetical errors will be rectified on the following basis: If there is a discrepancy between the unit price and the total price per item that is obtained by multiplying the unit price and quantity, the unit price shall prevail and the total price per item will be corrected. If there is a discrepancy between the Total Amount and the sum of the total price per item, the sum of the total price per item shall prevail and the Total Amount will be corrected.

Prior to the detailed evaluation, TPCODL will determine the substantial responsiveness of each Bid to the Bidding Documents including production capability and acceptable quality of the Goods offered. A substantially responsive Bid is one, which conforms to all the terms and conditions of the Bidding Documents without material deviation.

Bid determined as not substantially responsive will be rejected by the TPCODL and may not subsequently be made responsive by the Bidder by correction of the non-conformity.

4.4. Techno Commercial Clarifications

Bidders need to ensure that the bids submitted by them are complete in all respects. To assist in the examination, evaluation and comparison of Bids, TPCODL may, at its discretion, ask the Bidder for a clarification on its Bid for any deviations with respect to the TPCODL specifications and attempt will be made to bring all bids on a common footing. All responses to requests for clarification shall be in writing and no change in the price or substance of the Bid shall be sought, offered or permitted owing to any clarifications sought by TPCODL.

4.5. Price Bid Opening

Price bids will be opened internally without the presence of any bidder representative. The EMD of the bidder withdrawing or substantially altering his offer at any stage after the technical bid opening will be forfeited at the sole discretion of TPCODL without any further correspondence in this regard.

4.6. Reverse Auctions

TP CENTRAL ODISHA DISTRIBUTION LIMITED

(A Tata Power & Odisha Govt. joint venture)

2nd Floor, IDCO Tower, Janpath, Bhubaneswar, Odisha 751022

TPCODL reserves the right to conduct the reverse auction (instead of public opening of price bids) for the products/ services being asked for in the tender. The terms and conditions for such reverse auction events shall be as per the Acceptance Form attached as Annexure VI of this document. The bidders along with the tender document shall mandatorily submit a duly signed copy of the Acceptance Form attached as Annexure VI as a token of acceptance for the same.

5 Award Decision

TPCODL will award the contract to the successful bidder whose bid has been determined to be the lowest-evaluated responsive bid as per the Evaluation Criterion mentioned at Clause 2.0. The Cost for the said calculation shall be taken as the all-inclusive cost quoted by bidder in Annexure I (Schedule of Items) subject to any corrections required in line with Clause 3.2 above. The decision to place purchase order/LOI solely depends on TPCODL on the cost competitiveness across multiple lots, quality, delivery and bidder's capacity, in addition to other factors that TPCODL may deem relevant.

TPCODL reserves the rights to award contract to one or more bidders so as to meet the delivery requirement or nullify award decision without assigning any reason thereof.

In case any supplier is found unsatisfactory during delivery process, the award will be cancelled and TPCODL reserves right to award contract to other suppliers who are found fit.

6 Order of Preference/Contradiction

In case of contradiction in any part of various documents in tender, following shall prevail in order of preference:

1. Schedule of Items (Annexure I)
2. Post Award Contract Administration (Clause 7.0)
3. Submission of Bid Documents (Clause 3.0)
4. Scope of Work and SLA (Annexure VII)
5. Technical Specifications (Annexure II)
6. Acceptance Form for Participation in Reverse Auction (Annexure VI)
7. General Conditions of Contract (Annexure VIII)

7 Post Award Contract Administration**7.1. Special Conditions of Contract**

- Rate contract shall be valid for a period of 1 years from the placement of Contract. Release Order (RO) shall be placed as per the requirement of TPCODL. Rate shall remain FIRM till the validity of Rate Contract.
- Business Associate (BA) shall submit applicable Performance Bank Guarantee as per GCC within 30 days of issuance of order. PBG applicable shall be 5% of Order Value. PBG submitted, shall be released after completion of applicable guarantee period plus one month.
- Any change in statutory taxes, duties and levies during the contract period shall be borne by TPCODL. However, in case of delay in work execution owing to reasons not attributable to TPCODL, any increase in total liability shall be passed on the Bidder, whereas any benefits arising owing to such statutory variation in taxes and duties shall be passed on TPCODL.
- Statutory Variations: Any changes in existing taxes/ Duties and levies, Introduction of new taxes and duties etc. during the period of the contract shall be paid at actuals to BA subject to BA shall submit the tax break up in details, however, where BA has quoted the all-inclusive prices and not shown the tax break-up, this clause will not be applicable. The date of issue of MDCC shall be used for this purpose.
- Quotation in all BOM items is mandatory, and bid shall be rejected if any line of found blank in un price bid.

TP CENTRAL ODISHA DISTRIBUTION LIMITED

(A Tata Power & Odisha Govt. joint venture)

2nd Floor, IDCO Tower, Janpath, Bhubaneswar, Odisha 751022

- There will be no price escalation given to bidder after issue the RO even if there is delayed the project due to ROW permission.
- Quotation in all BOM items is mandatory, and bid shall be rejected if any line of found blank in un price bid.
- In case any additional material is to be asked to supply after finalization of scope of work in the detailed Engineering, the Extra price and the extension of delivery time (if applicable) as the case may be mutually agreed between TPCODL and Successful Bidder.

7.2 Warranty period: 18 months from the date of supply or 12 months from the date of commissioning whichever is earlier.

- All other terms and conditions of TPCODL General Conditions of Contract shall be applicable.

Terms of Payment:

On delivery of the materials in good condition and certification of acceptance by certified official, Associate shall submit the Bills/ Invoices in original in the name of TPCODL to Invoice Desk. The payment shall be released within 45 days from the date of submission of certified bills/ invoices.

7.3 Drawing Submission and Approval

The relevant drawings and GTPs need to be submitted within two weeks of receipt of firm purchase order by the successful bidder to TPCODL for approval. In case, re-submission of drawings is required on request of TPCODL, same needs to be submitted back to TPCODL within 5 days of such request.

7.4 Delivery Timelines

Release Orders shall be placed against the awarded Rate Contract by TPCODL as and when the requirements arise & Delivery within 30 Days from RO.

7.5 Warranty Period

18 months from the date of supply or 12 months from the date of commissioning whichever is earlier.

7.6 Payment Terms

On delivery of the materials in good condition and certification of acceptance by certified official, Associate shall submit the Bills/ Invoices in original in the name of TP Central Odisha Distribution Limited to Invoice Desk. The payment shall be released within 45 days from the date of submission of certified bills/ invoices.

7.7 Climate Change

Significant quantities of waste are generated during the execution of project and an integrated approach for effective handling, storage, transportation and disposal of the same shall be adopted. This would ensure the minimization of environmental and social impact in order to combat the climate change. Please refer attached Environment Policy and Sustainability Policy, Annexure-XI for more details.

7.8 Ethics

TPCODL is an ethical organization and as a policy TPCODL lays emphasis on ethical practices across its entire domain. Bidder should ensure that they should abide by all the ethical norms and in no form either directly or indirectly be involved in unethical practice.

TPCODL work practices are governed by the Tata Code of Conduct which emphasizes on the following:

- We shall select our suppliers and service providers fairly and transparently.
- We seek to work with suppliers and service providers who can demonstrate that they share similar values. We expect them to adopt ethical standards comparable to our own.

TP CENTRAL ODISHA DISTRIBUTION LIMITED

(A Tata Power & Odisha Govt. joint venture)

2nd Floor, IDCO Tower, Janpath, Bhubaneswar, Odisha 751022

- Our suppliers and service providers shall represent our company only with duly authorized written permission from our company. They are expected to abide by the Code in their interactions with, and on behalf of us, including respecting the confidentiality of information shared with them.
- We shall ensure that any gifts or hospitality received from, or given to, our suppliers or service providers comply with our company's gifts and hospitality policy.
- We respect our obligations on the use of third party intellectual property and data.

Bidder is advised to refer Tata Code of Conduct (TCOC) attached at Annexure X for more information.

Any ethical concerns with respect to this tender can be reported to the following e-mail ID:

purchase@tpcentralodisha.com / pkjain@tatapower.com

8 Specification and standards

As per Annexure II

9 General Condition of Contract

Any condition not mentioned above shall be applicable as per GCC Annexure-VIII attached along with this tender.

10 Safety

All jobs under this tender have to be executed strictly in compliance to the Safety terms and Conditions of TP Central Odisha Distribution Limited. Please refer attached Safety terms and conditions, Annexure-IX, for details. Violation of Safety norms will result in Penalty as mentioned in the above document.

ANNEXURE I
Schedule of Items

SI No.	Item Description	HSN Code	Unit	Quantity (Q)	Unit Price (in Rs.) A	GST (in Rs.) B	Unit Price (All Inclusive) (in Rs.) A+B	Total Amount (in Rs.) Q x (A+B)
1.	V-Cross Arm 11kV		EA	3150				
2.	V-Cross Arm 33 kV			3654				
3.	Top Hamper 33 kV Cross Arm			3654				
4.	Top Hamper 11 kV Cross Arm			3150				
	Total							

NOTE:

- The overall period of the rate contract shall be for a period of 1 years and prices shall be firm till the validity of contract. Release order shall be issued as per requirement of TPCODL.
- The bids will be evaluated commercially on the overall lowest cost in line item basis.
- The unit price with GST in column no. 7, is landed price for TPCODL at their store Bhubaneswar / Cuttack. Refer CLAUSE 3.3 Bid Price.
- The bidders are advised to quote prices strictly in the above format. Failing to do so, bids are liable for rejection.
- Bidder needs to quote mandatorily for each line item of the BOQ.
- The bidder must fill each and every column of the above format. Mentioning “extra/inclusive” in any of the column may lead for rejection of the price bid.
- No cutting/ overwriting in the prices is permissible.



NIT No.: TPCODL/P&S/1000000082/2021-22

TP CENTRAL ODISHA DISTRIBUTION LIMITED
(A Tata Power & Odisha Govt. joint venture)
2nd Floor, IDCO Tower, Janpath Bhubaneswar, Odisha 751022

ANNEXURE II
Technical Specification

Attached as Annexure-A (Technical Specification)



NIT No.: TPCODL/P&S/1000000082/2021-22

TP CENTRAL ODISHA DISTRIBUTION LIMITED
(A Tata Power & Odisha Govt. joint venture)
2nd Floor, IDCO Tower, Janpath Bhubaneshwar, Odisha 751022

ANNEXURE III

Schedule of Deviations

*Bidders are advised to refrain from taking any deviations on this TENDER. Still in case of any deviations, all such deviations from this tender document shall be set out by the Bidders, Clause by Clause in this schedule and submit the same as a part of the **Technical Bid**.*

Unless specifically mentioned in this schedule, the tender shall be deemed to confirm the TPCODL's specifications:

S. No.	Clause No.	Tender Clause Details	Details of deviation with justifications

By signing this document we hereby withdraw all the deviations whatsoever taken anywhere in this bid document and comply to all the terms and conditions, technical specifications, scope of work etc. as mentioned in the standard document except those as mentioned above.

Seal of the Bidder:

Signature:

Name:



NIT No.: TPCODL/P&S/1000000082/2021-22

TP CENTRAL ODISHA DISTRIBUTION LIMITED
(A Tata Power & Odisha Govt. joint venture)
2nd Floor, IDCO Tower, Janpath Bhubaneshwar, Odisha 751022

ANNEXURE IV

Schedule of Commercial Specifications

(The bidders shall mandatorily fill in this schedule and enclose it with the offer Part I: Technical Bid. In the absence of all these details, the offer may not be acceptable.)

S. No.	Particulars	Remarks
1.	Prices firm or subject to variation (If variable indicate the price variation clause with the ceiling if applicable)	Firm / Variable
1a.	If variable price variation on clause given	Yes / No
1b.	Ceiling	----- %
1c.	Inclusive of GST	Yes / No (If Yes, indicate % rate)
1d.	Inclusive of transit insurance	Yes / No
2.	Delivery	Weeks / months
3.	Guarantee clause acceptable	Yes / No
4.	Terms of payment acceptable	Yes / No
5.	Performance Bank Guarantee acceptable	Yes / No
6.	Liquidated damages clause acceptable	Yes / No
7.	Validity (180 days) (From the date of opening of bid)	Yes / No
8.	Inspection during stage of manufacture	Yes / No
9.	Rebate for increased quantity	Yes / No (If Yes, indicate value)
10.	Change in price for reduced quantity	Yes / No (If Yes, indicate value)
11.	Covered under Small Scale and Ancillary Industrial Undertaking Act 1992	Yes / No (If Yes, indicate, SSI Reg'n No.)

Seal of the Bidder:

Signature:

Name:



NIT No.: TPCODL/P&S/1000000082/2021-22

TP CENTRAL ODISHA DISTRIBUTION LIMITED
(A Tata Power & Odisha Govt. joint venture)
2nd Floor, IDCO Tower, Janpath Bhubaneswar, Odisha 751022

ANNEXURE V

Checklist of all the documents to be submitted with the Bid

Bidder has to mandatorily fill in the checklist mentioned below:

S. No.	Documents attached	Yes / No / Not Applicable
1	EMD of required value	
2	Tender Fee as mentioned in this tender	
3	Signed copy of this tender as an unconditional acceptance	
5	Duly filled schedule of commercial specifications (Annexure IV)	
6	Sheet of commercial/technical deviation if any (Annexure III)	
7	Balance sheet for the last completed three financial years; mandatorily enclosing Profit & loss account statement	
8	Acknowledgement for Testing facilities if available (duly mentioned on bidder letter head)	
9	List of Machine/tools with updated calibration certificates if applicable	
10	Details of order copy (duly mentioned on bidder letter head)	
11	Order copies as a proof of quantity executed	
12	Details of Type Tests if applicable (duly mentioned on bidder letter head)	
13	All the relevant Type test certificates as per relevant IS/IEC (CPRI/ERDA/other certified agency) if applicable	
14	Project/supply Completion certificates	
15	Performance certificates	
16	Client Testimonial/Performance Certificates	
17	Credit rating/solvency certificate	
18	Undertaking regarding non blacklisting (On company letter head)	
19	List of trained/untrained Manpower	

Seal of the Bidder:

Signature:

Name:



NIT No.: TPCODL/P&S/1000000082/2021-22

TP CENTRAL ODISHA DISTRIBUTION LIMITED
(A Tata Power & Odisha Govt. joint venture)
2nd Floor, IDCO Tower, Janpath Bhubaneswar, Odisha 751022

ANNEXURE VI

ACCEPTANCE FORM FOR PARTICIPATION IN REVERSE AUCTION EVENT

(To be signed and stamped by the bidder)

In a bid to make our entire procurement process more fair and transparent, TPCODL intends to use the reverse auctions as an integral part of the entire tendering process. All the bidders who are found as technically qualified based on the tender requirements shall be eligible to participate in the reverse auction event.

The following terms and conditions are deemed as accepted by the bidder on participation in the bid event:

1. TPCODL shall provide the user id and password to the authorized representative of the bidder. *(Authorization Letter in lieu of the same shall be submitted along with the signed and stamped Acceptance Form).*
2. TPCODL will make every effort to make the bid process transparent. However, the award decision by TPCODL would be final and binding on the supplier.
3. The bidder agrees to non-disclosure of trade information regarding the purchase, identity of TPCODL, bid process, bid technology, bid documentation and bid details.
4. The bidder is advised to understand the auto bid process to safeguard themselves against any possibility of non-participation in the auction event.
5. In case of bidding through Internet medium, bidders are further advised to ensure availability of the entire infrastructure as required at their end to participate in the auction event. Inability to bid due to telephone line glitch, internet response issues, software or hardware hangs, power failure or any other reason shall not be the responsibility of TPCODL.
6. In case of intranet medium, TPCODL shall provide the infrastructure to bidders. Further, TPCODL has sole discretion to extend or restart the auction event in case of any glitches in infrastructure observed which has restricted the bidders to submit the bids to ensure fair & transparent competitive bidding. In case of an auction event is restarted, the best bid as already available in the system shall become the start price for the new auction.
7. In case the bidder fails to participate in the auction event due any reason whatsoever, it shall be presumed that the bidder has no further discounts to offer and the initial bid as submitted by the bidder as a part of the tender shall be considered as the bidder's final no regret offer. Any offline price bids received from a bidder in lieu of non-participation in the auction event shall be out-rightly rejected by TPCODL.
8. The bidder shall be prepared with competitive price quotes on the day of the bidding event.
9. The prices as quoted by the bidder during the auction event shall be inclusive of all the applicable taxes, duties and levies and shall be FOR at TPCODL site.
10. The prices submitted by a bidder during the auction event shall be binding on the bidder.
11. No requests for time extension of auction event shall be considered by TPCODL.
12. The original price bids of the bidders shall be reduced on pro-rata basis against each line item based on the final all-inclusive prices offered during conclusion of the auction event for arriving at Contract amount.

Signature & Seal of the Bidder



NIT No.: TPCODL/P&S/1000000082/2021-22

TP CENTRAL ODISHA DISTRIBUTION LIMITED
(A Tata Power & Odisha Govt. joint venture)
2nd Floor, IDCO Tower, Janpath Bhubaneshwar, Odisha 751022



NIT No.: TPCODL/P&S/1000000082/2021-22

TP CENTRAL ODISHA DISTRIBUTION LIMITED
(A Tata Power & Odisha Govt. joint venture)
2nd Floor, IDCO Tower, Janpath Bhubaneswar, Odisha 751022

ANNEXURE VII

Scope of Work & Service level agreement

NA



NIT No.: TPCODL/P&S/1000000082/2021-22

TP CENTRAL ODISHA DISTRIBUTION LIMITED
(A Tata Power & Odisha Govt. joint venture)
2nd Floor, IDCO Tower, Janpath Bhubaneshwar, Odisha 751022

ANNEXURE- VIII

GENERAL CONDITIONS OF CONTRACT FOR SUPPLY ORDERS

CONTENTS	
CLAUSE NO.	DESCRIPTION
1.0	ORGANIZATIONAL VALUES
2.0	ETHICS
3.0	CONTRACT PARAMETERS
3.1	Issue/Award of Contract
3.2	Contract Commencement Date
3.3	Contract Completion Date
3.4	Contract Period/ Time
3.5	Contract Execution Completion Date
3.6	Contract Price /Value
3.7	Contract Document
3.8	Contract Language
3.9	Reverse Auction
4.0	SCOPE OF WORK
5.0	PRICES/RATES/TAXES
5.1	Changes in statutory Tax Structure
6.0	TERMS OF PAYMENT
6.1	Quantity Variation
6.2	Full and Final Payment
7.0	MODE OF PAYMENT
8.0	SECURITY CUM PERFORMANCE DEPOSIT
9.0	STATUTORY COMPLIANCE
9.1	Compliance to Various Acts
9.2	SA 8000
9.3	Affirmative Action



NIT No.: TPCODL/P&S/1000000082/2021-22

TP CENTRAL ODISHA DISTRIBUTION LIMITED
(A Tata Power & Odisha Govt. joint venture)
2nd Floor, IDCO Tower, Janpath Bhubaneshwar, Odisha 751022

CONTENTS	
CLAUSE NO.	DESCRIPTION
10.0	QUALITY
10.1	Knowledge of Requirements
10.2	Material/Equipment/Works Quality
10.3	Adherence to Rules & Regulations
10.4	Specifications and Standards
11.0	INSPECTION/PARTICIPATION
11.1	Right to Carry Out Inspection
11.2	Facilitating Inspection
11.3	Third Party Nomination
11.4	Waiver of Inspections
11.5	Incorrect Inspection Call
12.0	MDCC & DELIVERY OF MATERIALS
12.1	Material Dispatch Clearance Certificate
12.2	Right to Rejection on Receipt
12.3	Consignee
12.4	Submission of Mandatory Documents on Delivery
12.5	Dispatch and Delivery Instructions
13.0	GUARANTEE
13.1	Guarantee of Performance
13.2	Guarantee period
13.3	Failure in Guarantee period (GP)
13.4	Cost of repairs on failure in GP
13.5	Guarantee Period for Goods Outsourced
13.6	Latent Defect
13.7	Support beyond the Guarantee Period
14.0	LIQUIDATED DAMAGES
14.1	LD Waiver Request
15.0	UNLAWFUL ACTIVITIES
16.0	CONFIDENTIALITY



NIT No.: TPCODL/P&S/1000000082/2021-22

TP CENTRAL ODISHA DISTRIBUTION LIMITED
(A Tata Power & Odisha Govt. joint venture)
2nd Floor, IDCO Tower, Janpath Bhubaneshwar, Odisha 751022

CONTENTS	
CLAUSE NO.	DESCRIPTION
16.1	Documents
16.2	Geographical Data
16.3	Associate's Processes
16.4	Exclusions
16.5	Violation
17.0	INTELLECTUAL PROPERTY RIGHTS
18.0	INDEMNITY
19.0	LIABILITY & LIMITATIONS
19.1	Liability
19.2	Limitation of Liability
20.0	FORCE MAJEURE
21.0	SUSPENSION OF CONTRACT
21.1	Suspension for Convenience
21.2	Suspension for Breach of Contract Conditions
21.3	Compensation in lieu of Suspension
22.0	TERMINATION OF CONTRACT
22.1	Termination for Default/Breach of Contract
22.2	Termination for Convenience of Associate
22.3	Termination for Convenience of TPCODL
23.0	DISPUTE RESOLUTION AND ARBITRATION
23.1	Governing Laws and jurisdiction
24.0	ATTRIBUTES OF GCC
24.1	Cancellation
24.2	Severability
24.3	Order of Priority
25.0	ERRORS AND OMISSIONS
26.0	TRANSFER OF TITLES
27.0	INSURANCE
28.0	SUGGESTIONS & FEEDBACK



NIT No.: TPCODL/P&S/1000000082/2021-22

TP CENTRAL ODISHA DISTRIBUTION LIMITED
(A Tata Power & Odisha Govt. joint venture)
2nd Floor, IDCO Tower, Janpath Bhubaneshwar, Odisha 751022

CONTENTS	
CLAUSE NO.	DESCRIPTION
29.0	CONTACT POINTS
30.0	LIST OF ANNEXURES

TP CENTRAL ODISHA DISTRIBUTION LIMITED
(A Tata Power & Odisha Govt. joint venture)

2nd Floor, IDCO Tower, Janpath Bhubaneshwar, Odisha 751022

1.0 ORGANIZATIONAL VALUES

The TPCODL Group has always been a value driven organization. These values continue to direct the Group's growth and businesses. The six core Tata Values underpinning the way we do business are:

Integrity - We must conduct our business fairly, with honesty and transparency. Everything we do must stand the test of public scrutiny.

Understanding - We must be caring, respectful, compassionate and humanitarian towards our colleagues and customers around the world and always work for the benefit of India.

Excellence - We must constantly strive to achieve the highest possible standards in our day to day work and in the quality of goods and services we provide.

Unity - We must work cohesively with our colleagues across the group and with our customers and partners around the world to build strong relationships based on tolerance, understanding and mutual co-operation.

Responsibility - We must continue to be responsible and sensitive to the countries, communities and environments in which we work, always ensuring that what comes from the people goes back to the people many times over.

Agility - We must work in a speedy and responsive manner and be proactive and innovative in our approach.

2.0 ETHICS

In our effort towards Excellence and in Management of Business Ethics at TPCODL, an Ethics Management Team is constituted.

The main objective of the Ethics Management Team is to:

1. Record, address and allay the issues and concerns on ethics raised by different stakeholders like employees, consumers, vendors, Associates etc. by initiating immediate corrective actions.
2. Ensure proper communication of the ethics policies and guidelines through prominent displays at all offices of TPCODL and through printed declarations in all concerned documents where external stakeholders are involved.
3. Ensure proper framework of policies as preventive measures against any ethics violation recorded by them.
4. Prepare and submit MIS of all issues and concerns, corrective and preventive actions on monthly basis to the top management for their information.

All Associates and Stakeholders are requested to register any grievance on ethics violation on our website

www.tpcentralodisha.com

3.0 CONTRACT PARAMETERS

3.1 Issue/Award of Contract

TPCODL awards the contract to the Associate in writing in the form of Purchase Order (PO) or Rate Contract (RC), hereafter referred as Contract, through in any or all of following modes physical handover / post / e-mail / web document / fax with all the attachments/enclosures which shall be part of the contract document.

On receipt of the contract, the associate shall return to TPCODL copy of the contract document duly signed by legally authorized representative of associate, within two days of Effective Date of Contract for contracts having contract execution time less than 30 days and within five days for all other contracts.

3.2 Contract Commencement Date

The date of issue/award of contract shall be the Effective Date of Contract or Contract Commencement date.

3.3 Contract Completion Date

The date of expiry of Guarantee Period shall be deemed as the Contract Completion Date.

3.4 Contract Period/Time

The period from Contract Commencement Date to Contract Completion Date shall be deemed as the Contract Period/Time.

3.5 Contract Execution Completion Date

The stipulated date for completing the supply as per schedule of quantities shall be deemed as the Contract Execution Completion Date.

3.6 Contract Price /Value

The total all inclusive price/value mentioned in the PO/RC is the Contract Price/Value and is based on the quantity, unit rates and prices quoted and awarded and shall be subject to adjustment based on actual quantities supplied and accepted and certified by the authorized representative of the company unless otherwise specified in schedule of quantities or in contract documents.

3.7 Contract Document

The Contract Document shall mean and include but not limited to the following:

- NIT/Tender Enquiry, QR, Instruction to Bidders, Special Condition of Contract (SCC) of tender, GCC, Technical & Commercial Specifications including relevant annexure and attachments).
- Bids & Proposals Received from Associate including relevant annexure/attachments.
- RC/PO with agreed deviations from the tender/bid documents.
- All the Inspection and Test reports, Detailed Engineering Drawings.
- Material Dispatch Clearance Certificate (MDCC).

- Minutes of Meeting (MoM)

3.8 Contract Language

All documents, instructions, catalogues, brochures, pamphlets, design data, norms and calculations, drawings, operation, maintenance and safety manuals, reports, labels, on deliveries and any other data shall be in English Language.

The Contract documents and all correspondence between the TPCODL, Third Parties associated with the contract, and the Associate shall be in English language.

However, all signboards required indicating "Danger" and/or security at site and otherwise statutory required shall be in English, Hindi, and local languages.

3.9 Reverse Auction

TPCODL reserves the right to conduct the reverse auction (instead of public opening of price bids) for the products / services being asked for in the tender. The terms and conditions for such reverse auction events shall be as per the Acceptance Form attached in Annexure F. The bidders along with the tender document shall mandatorily submit a duly signed copy of the Acceptance Form as mentioned in the Annexure J as a token of acceptance for the same.

4.0 SCOPE OF WORK

All the activities that are to be undertaken by the Associate to realize the contractual deliverables in completeness form Scope of Work. Following clauses list, but not limited to, major requirements of the scope of work.

The associate shall satisfy himself and undertake fully the technical/commercial requirements of items to be supplied as listed in the Schedule of Quantities together with the tests to be performed /test reports to be furnished before dispatch, arrangement of stage and final inspections during manufacturing as per terms and conditions of contract, technical parameters & delivery terms and conditions including transit insurance to be met in order to fully meet TPCODL's requirements.

Completeness: Any supplies and services which might have not been specifically mentioned in the Contract but are necessary for the scope mentioned in Special Terms & Conditions and/or completeness of the works at the highest possible level, including any royalties, license fees & compensation to be paid, whether incurred by the associates or by a third party for the work covered in the scope, regardless of when incurred, shall be supplied/provided by the associate without any extra cost and within the time schedule for efficient, smooth and satisfactory operation and maintenance of the works at the highest possible level under Indian conditions (but according to international standards for facility of this type), unless expressly excluded from the scope of supplies and services in this Contract.

TPCODL have the right, during the performance of the Contract, to change the scope and/or technical character of the Project and/or of the supplies and services stipulated in the Contract by submitting a request in writing to the Associate. The Associate shall, within fifteen days of receipt of such request from the TPCODL, provide Purchaser with a reasonably detailed estimate of the cost of the change outlined in the request.

TP CENTRAL ODISHA DISTRIBUTION LIMITED
(A Tata Power & Odisha Govt. joint venture)
2nd Floor, IDCO Tower, Janpath Bhubaneswar, Odisha 751022

In the event, TPCODL requests a change, the Contract price and time shall be adjusted upwards or downwards, as the case may be and shall be mutually agreed to. The associate shall not be entitled to any extension of time unless such changes adversely affect the time schedule.

The Associate shall not proceed with the changes as requested till adjustment of contract price and time schedule where so applicable in terms of or otherwise directed by the TPCODL.

5.0 PRICES/RATES/TAXES

Unless specified elsewhere in the contract document, the prices/rates are inclusive of cost of finished product for which MDCC will be issued by TPCODL, packaging and forwarding charges, freight and transit insurance charges covering loading at Associate's works, transportation to TPCODL store/site & unloading & delivery at TPCODL stores/TPCODL site, cost of documentation including all the relevant test certificates and other supportive documents to be furnished.

The Prices/Rates are inclusive of all taxes, levies, cess and duties, particularly Goods and Services Tax as applicable. All government levy / taxes shall be paid only when the invoice is submitted according to the relevant act.

The prices/rates shall remain firm till actual completion of entire supply of goods/material/equipment as per contract is achieved and shall remain valid till the completion of the contract.

The prices shall remain unchanged irrespective of TPCODL making changes in quantum in all or any of the schedules of items of contract.

5.1 Changes in Statutory Tax Structure

If rate of any or all of the statutory taxes and duties applicable to the contract changes, such changes shall be incorporated by default if the changes occur within the contract execution time and shall be applicable if the contract is executed by the Associate within the Contract Execution Time.

For execution of contracts beyond contract execution time, where the delay is not attributable to TPCODL no upward revision in tax /duties shall be considered irrespective of changes in the statutory tax structure either within the contract execution time or beyond. However, in such cases, benefits due to any downward revisions in statutory tax rates shall be passed on to TPCODL.

6.0 TERMS OF PAYMENT

On delivery of the materials in good condition and certification of acceptance by TPCODL official, Associate shall submit the Bills/Invoices in original in the name of "The TP Central Odisha Distribution Limited" to invoice desk, complete with all required documents as under:

- Test Reports (4 sets).
- MDCC issued by TPCODL.
- Packing List.

- Drawing and Catalogue.
- Guarantee/Warrantee Card.
- Delivery Challan.
- O&M Manual.
- Copy of Order.
- Minutes of Meeting.

Bills/ invoices shall mention Supplier's GST Number. TPCODL will make 100% payment within 30 days of submission of the Bill/Invoice complete in all respects and along with all the requisite documents mentioned above, subject to condition that Associate has furnished the requisite Security-cum-Performance Guarantee as stipulated in the contract.

6.1 Quantity Variation

Payment will be made on the basis of actual quantity of supplies/actual measurement of works accepted by TPCODL and not on the basis of contract quantity.

6.2 Full and Final Payment

Full & Final Payment in all contracts shall be made subject to the associate submitting "No Demand Certificate" in the format as per Annexure-C.

7.0 MODE OF PAYMENT

Payment shall be made through crossed Cheque or RTGS whichever of the two modes chosen by the Associate, in favour of Associate's Bank Account on TPCODL records, on whose name Contract has been issued. Those Associates opting for the RTGS mode shall submit the details of Bank Account and other details as per annexure G. Further, for any payments made, TPCODL is not responsible for any consequences/disputes Associate have among the owners channel partners, sub-Associates and all such dispute/concerns shall be settled solely by the Associate.

8.0 SECURITY CUM PERFORMANCE DEPOSIT

Associates shall submit within 15 days from the effective date of issue of PO/RC, Security Performance Bank Guarantee (SPBG) in the format as per Annexure B of this document from banks acceptable to TPCODL for:

- (a) 5% of the PO value if purchase order value is more than Rs 5 Crores.
- (b) 10% of the PO value if purchase order value is less than Rs 5 Crores.

This shall remain valid till the end of the Guarantee Period of contract, plus one month.

- (c) 5% of the RC value in case of Rate Contract. This shall remain valid till the Guarantee period plus one month.

- For PO/RC values less than Rs. 5 lacs, Associate may request for deduction of amount equivalent to SPBG value from their first invoice. Such amount shall be withheld by TPCODL while processing the invoice and shall be released after completion of Guarantee Period plus one month.
- For PO/RC values less than Rs. 3 lacs, the clause (8.0) for Security cum Performance Bank Guarantee (SPBG) shall not be applicable.
- In case of RC (Rate Contract) after the expiry of RC validity, Associate shall have to submit SPBG. However, the Associate has the option to re-submit the SPBG as per actual RO
(Release Order) value issued against the RC, valid for Guarantee Period plus one month. The Guarantee Period shall be considered as per the last RO issued against the said RC. The original SPBG as submitted against the RC shall be released on submission of the new SPBG to TPCODL. Alternatively, Associate may extend the validity of original SPBG only till the requisite period, i.e. Guarantee Period plus one month.

9.0 STATUTORY COMPLIANCE

9.1 Compliance to Various Acts

Associate should ensure adherence to all applicable laws, rules and regulation applicable under this contract from time to time. In case of violation any risk, costs etc shall be in associates account and keep TDPPL indemnified always till completion of contracts.

9.2 SA 8000

As TPCODL is SA 8000 compliant, it expects its Associates to follow guidelines of SA 8000:2014 on the following aspects

1. Child Labour
2. Forced or Compulsory Labour
3. Health & Safety
4. Freedom of Association & Right to Collective Bargaining
5. Discrimination
6. Disciplinary Practices
7. Working Hours
8. Remuneration
9. Management System

9.3 Affirmative Action

TPCODL appreciate and welcome the engagement/employment of persons from SC/ST community or any other deprived section of society by their business associates.

Relaxation in Contract Clauses under Affirmative Action for SC/ ST Business Associates**

TPCODL believes that inclusive growth is the key to sustainable development, and to promote the same Policy on Affirmative Action for Scheduled Caste & Scheduled Tribe Communities has been adopted across the company.

Under the same pre-text, and to promote entrepreneurship among SC/ST community TPCODL has taken initiative by proposing relaxations in contract clauses as per below:

S. No	Initiative	for SC/ ST BA's	Guideline Document
1	Tender Fees	100% waiver for SC/ST community	All Open Tenders
2	Earnest Money Deposit	50 % relaxation of estimated EMD value	All limited and Open Tenders
3	Performance Bank Guarantee	50% relaxation in PBG for order value above 50 lacs else 25% relaxation	All limited and Open tenders

4	Turnover	25% relaxation in company turnover under qualifying requirement criteria	All Open Tenders
---	----------	--	------------------

****Classification of BAs under SC/ST shall be governed under following guidelines:**

- Proprietorship/ Single Ownership Firm: Proprietor of the firm should be from SC/ST community. Governing document shall be duly audited balance Sheet for the last FY bearing the name of proprietor.
- Partnership Firm: Only such firms shall qualify which have SC/ST partners holding equal to or more than 50% of the total ownership pattern of the firm. Governing document shall be Partnership Deed and audited balance sheet/ ITR for last FY.
- Private limited company: Only such firms shall qualify which have SC/ST directors holding equal to or more than 50% of the total ownership pattern of the firm. Governing document shall be Memorandum of Understanding (MoU) and/or Article of Association (AoA).

Governing document shall be Memorandum of Understanding (MoU) and/or Article of Association (AoA).

Note: Certification from SC/ST commission shall be required for deciding upon SC/ST status of a person.

10.0 QUALITY

10.1 Knowledge of Requirements

The Associate shall be deemed to have carefully examined and to have knowledge of the equipment, the general and other conditions, specifications, schedules, drawings, etc. forming part of the Contract and also to have satisfied himself as to the nature and character of the work to be executed and the type of the equipment and duties required including wherever necessary of the site conditions and relevant matters and details. Any information thus procured or otherwise obtained from TPCODL/Consultants shall not in any way relieve the Associate from his responsibility and executing the works in accordance with the terms of contract.

10.2 Material/Equipment/Works Quality

The items / works under the scope of the Associate shall be of the best quality and workmanship according to the latest engineering practice and shall be manufactured from materials of best quality considering strength and durability for their best performance and, in any case, in accordance with the specifications set forth in this Contract. All material shall be new. Substitution of specified material or variation from the process of fabrication/ construction/ manufacture may be permitted but only with the prior written approval of the TPCODL.

10.3 Adherence to Rules & Regulations

The Associate shall procure and/or fabricate/erect all materials and equipment in accordance with all requirements of Central and State enactment, rules and regulations governing such work in India and at site. This shall not be

TP CENTRAL ODISHA DISTRIBUTION LIMITED
(A Tata Power & Odisha Govt. joint venture)
2nd Floor, IDCO Tower, Janpath Bhubaneshwar, Odisha 751022

construed as relieving the Associate from complying with any requirement of TPCODL as enumerated in the Contract which may be more rigid than and not contrary to the above mentioned rules, nor providing such construction as may be required by the above mentioned rules and regulations. In case of variance of the Technical Specification from the laws, ordinance, rules and regulations governing the work, the Associate shall immediately notify the same to the TPCODL. It is the sole responsibility of the Associate, however, to determine that such variance exists. Wherever required by rules and regulations, the Associate shall also obtain the statutory authorities' approval for the plant, machinery and equipment to be supplied by the Associate.

10.4 Specifications and Standards

The Associate shall follow all codes and standards referred in the Contract Document. Codes and standards of other may be followed by the Associate with the prior written approval of TPCODL, provided materials, supplies and equipment according to the standard are equal to or better than the corresponding standards specified in the Contract.

Brand names mentioned in the Contract documents are for the purpose of establishing the type and quality of products to be used. The Associate shall not change the brand name and qualities of the bought out items without the prior written approval of the TPCODL. All such products and equipment shall be used or installed in strict accordance with original manufacturer's recommendations, unless otherwise directed by the TPCODL. In any circumstances the codes, specimen and standards prescribed by any government agency should not be violated.

11.0 INSPECTION/PARTICIPATION

11.1 Right to Carry Out Inspection

TPCODL reserves the right to send its representatives for inspection or participation at various stages of contract execution listed below, applicable as per contract construction.

- During basic design and detail engineering of material/ Equipment carried out by Associate /Outsourced Agencies.
- During manufacturing stages of the product at Associate's/Associate's Outsourced Agency's Plant/Facility.
- During Pre-dispatch Inspection and Testing of finished/manufactured product at Associate's/Associate's outsourced Agency's Plant/Facility.
- During Installation & Commissioning Activities/Stages.
- Prior to Clearing of the completed installation for commissioning.
- Any other stage as find appropriate by TPCODL during contract execution time.

All inspections and participations shall be carried out by TPCODL giving written intimation to the Associate or receiving appropriate advance written inspection call from the Associate, unless otherwise specified elsewhere in the contract document.

11.2 Facilitating Inspection

The Associate shall provide all opportunities and information to TPCODL's engineers to get acquainted with the technical know-how and the methods and practices adopted by the Associate in basic and detail engineering. The Associate shall provide documents, drawings, calculations etc. as may be required by TPCODL's Engineers.

The Associate shall provide free of charge office accommodation, office facilities, secretarial services, communication facilities, general and drawing office stationary, etc. as may be reasonably required by the TPCODL's engineers. Similarly, facilities shall also be provided by Associate's outsource agencies/partners/authorized dealers (collectively termed as sub associates) if such basic and detail engineering activities are carried out in the design offices of sub-Associates.

The Associate shall be responsible for the safety of employees of TPCODL/Third Party Agency when they are at the Associate's /Associate's outsource agency's plant or facility for carrying out/witnessing inspection/testing. All statutory safety precautions as applicable shall be followed by the Associate during Inspection Testing. If TPCODL inspectors are not satisfied with the safety arrangements at the plant, TPCODL have the right to call off inspection till such time corrective action is taken by the Associate.

Before raising the call for pre-dispatch final inspection and testing, the Associate shall conduct all the tests—type tests, routine tests etc-as specified in the contract document and submit copies of the test certificates to TPCODL along with the inspection call, for scrutiny of TPCODL.

The Associate and TPCODL shall jointly document all the observations, comments and action points after completion of inspection and it shall be binding on the Associate to provide compliance on all the points requiring compliance and furnish the compliance report to the designated authority of TPCODL for receiving clearance for dispatch of materials

11.3 Third Party Nomination

TPCODL also may nominate a third party for the purpose of carrying out the inspection and such an agency shall be entitled to all the rights and privileges of TPCODL as far as conducting the inspection.

11.4 Waiver of Inspections

TPCODL on its own discretion shall chose to waive off any inspection and ask the Associate to submit all the test reports as applicable as per contract specifications, related to inspection and testing of the goods ordered for scrutiny and clearance for dispatch.

11.5 Incorrect Inspection Call

In case it is observed that the material offered for inspection is not ready at the time of TPCODL inspection visit rendering it as futile, all costs towards such inspection shall be recovered from the BA. Taxes as applicable on such recoveries shall be borne by the BA.

12.0 MDCC & DELIVERY OF MATERIALS

12.1 Material Dispatch Clearance Certificate

Associate shall deliver material/goods/equipment against Supply Contracts or Supply Part of Composite/Service Contracts only after receiving Material Dispatch Clearance Certificate (hereafter termed as MDCC) issued by designated authority of TPCODL. Material delivered at TPCODL stores or at project site without a valid MDCC issued by the designated official of TPCODL shall be rejected. MDCC shall be issued to associate furnishing compliance report on the action points documented during pre-dispatch inspection and testing at Associate's/ Sub Associate's plant/ facility. In case Pre-dispatch inspection is waived at the discretion of TPCODL, then, MDCC shall be issued on receiving all the test reports-routine& type-from the Associate and finding them in order.

The associate shall include and provide for securely protecting and packing the materials so as to avoid loss or damage during handling and transport by air, sea, rail and road or any other means.

All such packing shall allow to the extent possible for easy removal and checking at Site. The associate shall take special precautions to prevent rusting of steel and iron parts during transit by sea. Gas seals or other materials shall be utilized by the associate for protection against moisture during transit of all Plant and Equipment.

Each Equipment or parts of Equipment shall be tagged with reference to the assembly drawings and corresponding part numbers. Each bale or package shall contain a packing note quoting specifically the name of the associate, item description, quantity, item / package identification.

All packing cases, containers, packing and other similar materials shall be new and supplied free by the associate and it shall not be required to be returned to the associate.

Notwithstanding anything stated in this clause, the associate shall be entirely responsible for loss, damage or depreciation or deterioration to the materials and supplies due to faulty and/or insecure packing or otherwise during transportation to the Site until otherwise provided herein.

In case of the consignments dispatched by road, the associate shall ensure that it or its subcontractors:

- i) Identify and obtain the correct type of trucks/trailers, keeping in view the nature of consignments to be dispatched.
- ii) Take such actions as may be necessary to avoid all possible chances of damages during transit and to ensure that all packages are firmly secured.

Timelines for inspection and MDCC is as below:

S. No.	Inspection	MDCC issuance time including Inspection time (max.)
1	Outside Bhubaneswar	12 days
2	Within Bhubaneswar	5 days
3	Waiver*	3 working days

* Associate is expected to raise the inspection call assuming that Inspection shall be carried out by TPCODL. The decision for waiver of inspection shall be on sole discretion of TPCODL.

12.2 Right to Rejection on Receipt

Goods/Material/Equipment delivered in condition physically damaged & incomplete as a product ordered, or not packed and transported as per the terms and conditions of the contract is liable to be rejected. Such item shall be lifted back by Associates within 15 days from receipt of rejection note from TPCODL and have to supply back the material within next 30 days or within the timeframe mutually decided by Associate and TPCODL.

If delivery of the material is beyond the agreed time, Liquidated damage clause, mentioned in this GCC separately shall be applicable; but the period for levy of LD shall be considered as per the original delivery schedule and not from the agreed timelines for material rectification.

12.3 Consignee

Unless otherwise specified in the Contract Document, Materials/Goods/Equipment shall be consigned to “Stores-In-Charge”, TPCODL, Bhubaneswar.

12.4 Submission of mandatory documents on Delivery

Following documents shall be mandatorily submitted by BA along with supply of material to TPCODL stores/site:

S. No.	Documents	Requisite
1	Invoice copy in original	With all consignments
2	LR copy	Wherever required
3	Packing list	With all consignments
4	MDCC	With all consignments
5	Purchase order / Release order	Signed copy
6	Test certificates	With all consignments
7	Inspection/JVR report	In case pre-dispatch inspection is conducted
8	Device data in CD as per template for metering items	Wherever applicable

12.5 Dispatch and Delivery Instructions

S. No.	Instructions
1	Purchase order/ Release order no. shall be mentioned on invoice and on material
2	TPCODL material code and material description shall be mentioned in invoice and on material.
3	“Property of TPCODL” shall be embossed on material.

4	The material shall be properly sealed and packed in standard packing as per purchase order terms & conditions.
5	The weight and quantity of material shall be mentioned wherever applicable
6	The material supplied shall be co-related with the packing list.
7	The name plate detail on equipment shall include Material code, Material description, specification detail of material [as applicable], Serial No. Year of manufacturing, PO/RO no. and date, "PROPERTY OF TPCODL, Bhubaneswar", Guarantee period and Associate's name.
8	In case of manual unloading, supplier / transporter shall deploy sufficient Labour for unloading the material at TPCODL central store. For heavy item(s), crane will be provided by TPCODL [unloading cost will be recovered from the associate].
9	The driver should have valid License and one helper in truck. All the documents of truck like registration papers, PUC etc. should be available in Truck.
10	BA representative should accompany the material and get it unloaded / stacked in his presence wherever possible.

13.0 GUARANTEE

13.1 Guarantee of Performance

Associates shall stand guarantee that the equipment and material supplied under the contract is free from design, manufacturing, material, construction, erection & installation and workmanship & quality defects and is capable of its due, rated and intended quality performance, as an integrated product delivered under the contract, for a specific period termed as Guarantee Period(as elaborated elsewhere in this clause). The Associate should also guarantee that the equipment/material is new and unused except for the usage required for the tests and checks required as part of quality assurance.

13.2 Guarantee Period

The Guarantee Period will be equipment/service/work specific and shall be as specified in the Standard Specifications of TPCODL for the equipment/material/service/work and where standard specifications are not part of contract documents or guarantee period is not specified in the standard specifications,, the guarantee period shall be as per the Special Terms and Conditions of the Contract. In case of no mention of the guarantee period in standard specifications or SCC Guarantee Period will be 60 Months from the Date of Commissioning or 72 months from the date of delivery of final lot of supplies made, whichever is earlier.

13.3 Failure in Guarantee Period (GP)

If the equipment and material supplied under the contract fails to perform its due, rated & intended quality performance, during the Guarantee period, the associate is liable to undertake repair/rectify/replace the equipment and material supplied within time frame specified in the SCC or elsewhere in the contract documents at associate's cost to make the equipment and material supplied/service or work rendered under the contract of performing its due, rated and intended quality performance. If Associate fails to repair/rectify/replace the equipment or material

TP CENTRAL ODISHA DISTRIBUTION LIMITED
(A Tata Power & Odisha Govt. joint venture)
2nd Floor, IDCO Tower, Janpath Bhubaneswar, Odisha 751022

supplied rendered under the contract, failed in Guarantee Period, TPCODL will be at liberty to get the same done at Associate's risks and costs and recover all such expenses plus the TPCODL's own charges (@ 20% of expenses incurred), from the Associate or from the "Security cum Performance Deposit" as the case may be.

If during the Warranty/ Guarantee period some parts of the supplies are replaced owing to the defects/ damages under the Warranty, the Warranty period for such replaced parts shall be until the expiry of twelve months from the date of such replacement or renewal or until the end of original Guarantee period, whichever is later.

Any repairs during the Guarantee Period shall be carried out by the Associate within 30 days of reporting the issue to Associate by TPCODL. However, if replacement of the Equipment is required, Associate shall notify the same to TPCODL within 7 days of reporting the issue by TPCODL. Thereafter, the total time for supply of new equipment/ material shall be equal to the original delivery period of that equipment/ material as specified in the Contract. In case the Associate is not able to rectify/ replace the faulty equipment/ material within the stipulated timelines as mentioned above, penalty shall be levied as per the Liquidated Damages clause mentioned in this document. The penalty amount shall be recovered from the payment due to the vendor or by encashment of the SPBG as the case may be.

13.4 Cost of repairs on failure in GP

The cost of repairs/rectification/replacement, required transportation, site inspection /mobilization/dismantling and re-installation costs as applicable, to be borne by Associate. The Associate has to ensure that the interruption in the usage of intended purpose of the equipment is minimized to the maximum extent In lieu of the time taken for repairs/rectification/replacement.

13.5 Guarantee period for Goods Outsourced

If the Associate outsources partly equipment/materials/services from third party as mutually agreed upon at the pre award stage of contract, TPCODL shall have the benefit of any additional guarantee period if provided by the third party for the part supplied/executed by them.

13.6 Latent Defect

Hidden defects in manufacturing or design of the product supplied and which could not be identified by the tests conducted but later manifested during operation of the equipment are termed as latent defects. Associates shall further be responsible for 'free replacement' for another period of THREE years from the end of the guarantee period for any 'Latent Defects' if noticed and reported by the Company.

13.7 Support beyond the Guarantee Period

The Associate shall ensure availability of spares and necessary support for a period of atleast 10 years post completion of guarantee period of equipment supplied against the contract.

14.0 LIQUIDATED DAMAGES

- a) For supplies which are of standalone use, multiple in quantities and having a single final delivery schedule, Liquidated damages shall be levied without prejudice to any of the other contractual rights of TPCODL, as described below:

For delay of each week and part thereof from the delivery schedule specified in the contract, 1% of contract value corresponding to undelivered quantity, provided full quantity is supplied within 130% of the original contract time. If full contractual quantity is not delivered within 130% of contract time for delivery, TPCODL has the right to levy LD on the entire contract value, subject to a maximum of 10% of the total contract value.

- b) For Supplies having phased delivery schedule as per contract terms, standalone use and multiple in quantities, Liquidated damages shall be levied without prejudice to any of the other contractual rights of TPCODL, as described below:

For the purpose of calculating and applying LD, each delivery lot shall be considered separately. For delay of each week and part thereof, from the delivery schedule specified for the lot, 1% of the contract value corresponding to the undelivered quantity of the lot subject to a maximum of 10% of the total contract value of the subject lot. However, if full contractual quantity is not delivered within 130% of contract time for delivery, TPCODL has the right to levy LD on the entire contract value, subject to a maximum of 10% of the total contract value. Deduction of LD shall be on landed cost i.e contract value inclusive of taxes and in pursuant statutory compliance GST would be applicable at the stipulated rate and the same shall be borne by Business Associate. In case of LD deduction, a GST invoice shall be issued by TPCODL as a proof of deduction/ recovery.

14.1 LD Waiver Request

Any request of LD waiver shall be submitted within thirty (30) days of deducting LD. Request submitted beyond the timeline shall not be entertained.

15.0 UNLAWFUL ACTIVITIES

The Associate shall have to ensure that none of its employees are engaged in any unlawful activities (whether covered under the scope of the present GCC or not) subversive of the TPCODL's interest failing which appropriate action (legal or otherwise) may be taken against the Associate by the TPCODL, in accordance with the terms of the present GCC.

16.0 CONFIDENTIALITY

Associate and its employees or representatives thereof shall strictly maintain the confidentiality of various information they come across while executing the contract as detailed below.

16.1 Documents

All maps, plans, drawings, specifications, schemes and other documents or information related to the Contract/Project and the subject matter contained therein and all other information given to the Associate by the

TPCODL in connection with the performance of the contract shall be held confidential by the Associate and shall remain the property of the TPCODL and shall not be used or disclosed to third parties by the Associate for any purpose other than for which they have been supplied or prepared. The Associate may disclose to third parties, upon execution of confidentiality agreements, such part of the drawings, specifications or information if such disclosure is necessary for the performance of the Work provided such third parties agree in writing to keep such information confidential to the same extent and degree as provided herein, for the benefit of the TPCODL.

16.2 Geographical Data

Maps, layouts and photographs of the unit/plant including its surrounding regions showing vital installation for national security of country or those of TPCODL shall not be published or disclosed to the third parties or taken out of the country without prior written approval of the TPCODL and upon execution of confidentiality agreements satisfactory to the TPCODL with such third parties prior to disclosure.

16.3 Associate's Processes

Title to secret processes if any developed by the Associate on an exclusive basis and employed in the design of the equipment shall remain with the Associate. TPCODL shall hold in confidence such processes and shall not disclose such processes to the third parties without prior approval of the Associate and execution by such third parties of secrecy agreements satisfactory to the Associate prior to disclosure. Upon completion of contract, such processes shall become the property of the TPCODL. Title to technical specifications, drawings, flow sheets, norms, calculations, diagrams, interpretations of test results, schematics, layouts and such other information, which the Associate has supplied to the TPCODL under the Contract shall be passed on to the TPCODL. The TPCODL shall have the right to use these for construction, erection, start-up, Trial Run, operation, maintenance, modifications and/or expansion of the works including for the manufacture of spare parts.

16.4 Exclusions

The provision of Clauses 16.1 to 16.3 shall not apply to information:

- Which at the time of disclosure are in the public domain which later on become part of public domain through no fault of the party concerned, or
- Which were in the possession of the party concerned prior to disclosure to him by the other party, or
- Which were received by the party concerned after the time of disclosure without restriction on disclosure or use, from a third party who did not acquire such information directly or indirectly from the other party or has no obligation of confidentiality for such information.

16.5 Violation

In case of violation of this clause, the Associate is liable to pay compensation and damages as may be determined by the competent authority of TPCODL.

17.0 INTELLECTUAL PROPERTY RIGHTS

If, in the course of performance of its functions and duties as envisaged by the scope of the present GCC, the Associate acquires or develops, any unique knowledge or information which would be covered, or, is likely to be covered within the definition of a trademark, copyright, patent, business secret, geographical indication or any other form of intellectual property right, it shall be obliged, under the terms of this present GCC, to share such knowledge or information with the TPCODL. All rights, with respect to, or arising from such intellectual property, as aforementioned, shall solely vest in TPCODL.

Moreover, the Associate undertakes not to breach any intellectual property right vesting in a third party/parties, whether by breach of statutory provision, passing off, or otherwise. In the event of any such breach, the Associate shall be wholly liable to compensate, indemnify or make good any loss suffered by such third party/parties, or any compensation/damages arising from any legal proceeding/s, or otherwise. No liability of TPCODL shall arise in this respect, and any costs, damages, expenses, compensation payable by TPCODL in this regard to a third party/parties, arising from a legal proceeding/s or otherwise, shall be recoverable from the Associate.

18.0 INDEMNITY

The Associate shall at all times indemnify, keep indemnified and hold harmless the TPCODL and its officers, directors, employees, affiliates, agents, successors and assigns against all actions, claims, demands, costs, charges and expenses arising from or incurred by reason of any infringement of patent, trade mark, registered design, copy rights and/or industrial property rights by manufacture, sale or use of the equipment supplied by the Associate whether or not the TPCODL is held liable for by any court judgement. In this connection, the TPCODL shall pass on all claims made against him to the Associate for settlement.

The Associate assumes responsibility for and shall indemnify and save harmless the TPCODL from all liability, claims, costs, expenses, taxes and assessments including penalties, punitive damages, attorney's fees and court costs which are or may be required to be paid by the TPCODL and its officers, directors, employees, affiliates, agents, successors and assigns arising from any breach of the Associate's obligations under the Contract or for which the Associate has assumed responsibilities under the Contract including those imposed under any local or national law or laws, or in respect to all salaries, wages or other compensation for all persons employed by the Associate or his Sub-Associates or suppliers in connection with the performance of any work covered by the Contract. The Associate shall execute, deliver and shall cause his Sub-Associate and suppliers to execute and deliver, such other further instruments and to comply with all the requirements of such laws and regulation as may be necessary there under to conform and effectuate the Contract and to protect the TPCODL.

The TPCODL shall not be held responsible for any accident or damages incurred or claims arising, due to the Associate's error there from prior to completion of work. The Associate shall be liable for such accidents and after completion of work for such accidents as the case may be due to negligence on his part to carry out Work in accordance with Indian laws and regulations and the specifications set forth herein.

19.0 LIABILITY & LIMITATIONS

19.1 Liability

Except for any specific liability which may be identified in the Contract and which may be payable hereunder, Associate shall not be liable for any special, incidental, indirect, or consequential Damages or any loss of business Contracts, revenues or other financial loss (or equivalents thereof no matter how claimed, computed or characterized) arising out of or in connection with the Performance of the Work or supply of Goods **unless caused by Associate's negligence, willful misconduct or breach of contract.**

If the Associate is a joint venture or consortium, all concerned parties shall be jointly and severally bound to the TPCODL for the fulfillment of the provisions of the Contract. The consortium or the joint venture shall designate one party as their leader, who will be the coordinator between the parties and TPCODL. The constituents & leader of the consortium or joint venture shall not be changed without the prior consent of TPCODL.

TPCODL shall have no liability or any special, incidental, indirect or consequential Damages for any loss of Business Contracts, revenues or other financial loss arising out of this Contract.

19.2 Limitation of Liability

The total liability of Associate against any contract shall be limited to the Total All Inclusive Contract Value.

20.0 FORCE MAJEURE

Force Majeure applies if the performance by either Party ("the Affected Party") of its obligations under Contract is materially and adversely affected.

"Force Majeure" shall mean any event or circumstance or combination of events or circumstances referred below and their consequences that wholly or partly prevents or unavoidably delays any Party in the performance of its obligations under this Agreement, but only and to the extent that such events and circumstances are not within the reasonable control, directly or indirectly, of the Affected Party and could not have been avoided even if the Affected Party had taken reasonable care:

- Act of war (whether declared or undeclared), invasion, armed conflict or act of foreign enemy, embargo, blockade, revolution, riot, bombs, religious strife or civil commotion, etc. ▪ Politically motivated sabotage, or terrorism, etc.
- Action or Act of Government or Governmental agency for which remedy is beyond the control of the affected parties. ▪ Any act of God.

Note: Causes like power breakdown/ shortages/fire/strikes, accidents etc do not fall under Force Majeure.

Time being the essence of the Contract, if either party is prevented from the performance of its obligations in whole or in part due to an event of Force Majeure, then provided Notice of happening of any event by the Affected Party is given to the other party within seven (7) days from the date of occurrence of such event, which DIRECTLY has impact on works and submitted details and quantum of resulting effect, but at the same time had made all possible efforts

to mitigate and overcome effects thereof, the Affected Party's performance under this Contract shall be suspended until such event ceases and the Scheduled Completion shall be delayed accordingly.

If Force Majeure event(s) continue for a period of more than three months, the parties shall hold consultation to discuss the further course of action.

Neither party shall be considered to be in default or in breach of its obligation under the Contract to the extent that performance of such obligation by either party is prevented by any circumstances of Force Majeure which arise after effective date of Contract.

Neither party can claim any compensation from the other party on account of Force Majeure.

21.0 SUSPENSION OF CONTRACT

21.1 Suspension for Convenience

TPCODL may, at any time and at its sole option, suspend execution of all or any portions of the schedule of items of contract to be supplied/work to be executed by Associate under the contract by providing to the Associate at least two business days written notice for contracts having contract completion period less than sixty days and at least seven business days' notice for all other contracts.

Upon receipt of any such notice, the Associate shall respond as follows as applicable as per contract construction.

- Immediately discontinue further supply of material/goods specified in the suspension notice for supply contracts
- Immediately discontinue further service/work and supply of materials of those services/materials/work specified in the suspension notice for service /composite contract
- Promptly make every reasonable effort to obtain suspension, upon terms satisfactory to TPCODL, of all orders, outsourcing arrangements, and rental Contracts to the extent that they relate to performance of the portion of Work suspended by the notice.
- Protect and maintain the portion of the service/Work already completed, including the portion of the Work suspended hereunder, unless otherwise specifically stated in the notice.
- Continue delivering/carrying out the supply/service/work items as per contract conditions, which do not fall under purview of the suspension notice.

On receipt of resumption notice from TPCODL, the Associate shall resume execution of contract as specified in the resumption notice, within the time frame specified in the resumption notice.

21.2 Suspension for Breach of Contract conditions.

TPCODL shall suspend execution of whole/or part thereof the contract till such time Associate complies with the conditions stipulated under section clause 22.1 for breach/default of contract conditions.

21.3 Compensation in lieu of Suspension

If the suspension of the contract in whole or in part is for convenience of TPCODL and not due to any breach of contract conditions by the associate, TPCODL at its discretion shall consider compensating all reasonable additional costs incurred by Associate in lieu of suspension of whole or part of contract, on representation of the Associate providing justified estimates of such additional costs and such estimates are found acceptable and approved by competent authority of TPCODL.

If the suspension of contract in whole or part thereof is due to breach of contract conditions (refer clause 22.1) by the Associate, Associate shall not be entitled for any compensation for any cost incurred in lieu of suspension of whole or part of contract and also shall be liable for compensating all the losses arising to TPCODL in lieu of suspension of contract. Resumption notice shall be subject to the Associate taking corrective action for the breach of contract conditions within the time frame and as per the terms specified in the suspension notice.

22 TERMINATION OF CONTRACT

22.1 Termination for Default/Breach of Contract

The contract / PO /RC shall be subject to termination by TPCODL in case of breach of the contract by the Associate which shall include but not be limited to the following:

- a. Withdrawal or intimation by the Associate of its intent to withdraw or surrender the execution / completion of the contracted work /PO or failure in ensuring adherence to any delivery schedules, in deviation of the contract/PO.
- b. Refusal or neglect on the part of the Associate to supply material/equipment of quantity or quality as specified by TPCODL and within the timeframe as specified in the contract document or refusal or neglect to execute the services/work in terms of the agreed standards of quantity or quality and/or within the timeframe specified in the contract/PO.
- c. Failure in any respect to perform any portion of the Work contracted with promptness, diligence, or in accordance with the terms of the contract.
- d. Failure to furnish guarantees as specified and /or failure to comply with the terms thereof.
- e. Failure to furnish such relevant documents or information within the time specified which may be necessary for due execution / completion of the works and documentation.
- f. Liquidation, bankruptcy either voluntary or involuntary OR entering into any composition or compromise with its creditors, or Insolvency.
- g. In case any reasonable information has been received by TPCODL that Associate has adopted/ or attempted to adopt any unethical conduct, action in award of the contract /PO or at any time thereafter.
- h. Failure to comply with applicable statutory provisions as contained in the contract or failure to comply with the applicable laws.

TP CENTRAL ODISHA DISTRIBUTION LIMITED
(A Tata Power & Odisha Govt. joint venture)
2nd Floor, IDCO Tower, Janpath Bhubaneshwar, Odisha 751022

- i. Failure to comply with safety regulations/clauses stipulated in the contract or as may be generally instructed by TPCODL.

If the default or breach as specified under clause 22 (except sub clause g thereof) be committed by the associate for the first time, TPCODL shall issue, along with notice of default or breach, a warning notice instructing the associate to take remedial/corrective action within the time frame stipulated in the warning notice and not to repeat the same in future. The timeframe for corrective action by the associate shall be specific to the nature of breach of contract and the same shall not be objected to by the Associate. If the Associate fails to comply with the instructions in the warning notice or in taking corrective action to the satisfaction of TPCODL then TPCODL may terminate the entire or part of contract at its discretion by issuing termination notice without incurring any liability on this ground.

In case the contract is terminated for any breach of the nature specified in clause 22 g stated above, TPCODL shall have the right to terminate all the contracts TPCODL is having with the Associate by issuing termination notice which shall be without prejudice to the other rights of TPCODL available to it under law.

Without prejudice to its right to terminate for breach of contract, TPCODL may, without assigning any reason, terminate the Contract in whole or in part at any time at its discretion while the contract is in force by serving a written notice of two weeks to the Associate.

In the event of TPCODL having proceeded with termination of the contract the associate shall comply and proceed further in the following manner:

- a) Associate shall discontinue the supply, on the expiry of the said period of two weeks.
- b) Associate shall ensure that no further steps are being taken towards discharge of the obligations, terms and conditions as contained in the contract/PO. This shall include initiation of actions not limited to discontinuation of other allied and associated arrangements which the associate might have entered into with third parties for due discharge of its obligations under the contract with TPCODL.
- c) The Associate shall perform thereafter such tasks as may be necessary to preserve and protect the terminated portion of the material/service/work in progress and the materials and equipment at TPCODL sites or in transit thereto. However the associate shall continue to fulfill its contractual obligations with regard to the part of contract not terminated.
- d) It shall be open for TPCODL to conduct a joint assessment with the associate of the material, supplies, equipment, works or in general as to the subject matter of the contract in regard to which the associate claims having completed its obligations before or during such termination.
- e) It shall be open to TPCODL to seek invocation of the performance bank guarantee or any other guarantee or other security deposit by whatever name called submitted by the associate, which shall not be objected to or protested against by the associate.

In case of termination of the contract the parties agree to be governed inter alia by the following:

- a) In case TPCODL exercises its right of termination as stated above the associate shall not dispute or object to the same.

TP CENTRAL ODISHA DISTRIBUTION LIMITED
(A Tata Power & Odisha Govt. joint venture)
2nd Floor, IDCO Tower, Janpath Bhubaneswar, Odisha 751022

- b) The Associate shall be entitled to receive and claim only such payments OR sums of money from TPCODL as may be found payable to it in regard to works executed by it under the terms of the contract and no other claim of any nature whatsoever shall be made by the Associate.
- c) All such provisions which the parties have agreed to survive and prevail even after termination of the contract shall remain effective despite the termination.

In the event of such termination, TPCODL may finish the Work by whatever method it may deem expedient, including the hiring of services and /or purchase of material equipment from such third parties as TPCODL may deem fit or may itself provide any labor or materials and perform any part of the Work. The associate undertakes to bear the incremental costs if any paid by TPCODL in such a case attributable to failure on the part of the associate. The Associate in such a case shall not be entitled to receive any further payments and any sums found payable to it may be adjusted by TPCODL against the amount recoverable from him on this ground. The same shall be without prejudice to other rights available to TPCODL under law against the associate.

Upon the termination of any of the contract due to occurrence of any circumstances provided in clauses stated above and constituting repeated breach or misconduct, TPCODL shall be entitled to bar the associates its agents, affiliates from undertaking any negotiation / tendering, bidding, participation activities concerning TPCODL for a period of two years from date of such termination. The same shall be without prejudice to other rights available to TPCODL.

22.2 Termination for Convenience of Associate

Associate at its convenience may request for termination of contract, clearly assigning the reason for such request. TPCODL has full right to accept, reject or partially accept such request. However, associate shall continue its supply as per contract till final approval is given to associates for such termination.

22.3 Termination for Convenience of TPCODL

TPCODL at its sole discretion may terminate the contract by giving 30 days prior notice in writing or through email to the Associate. TPCODL shall pay the Associate for all the supplies/ services rendered till the actual date of contract termination against submission of invoice by the Associate to that effect.

23.0 DISPUTE RESOLUTION & ARBITRATION

In case of any dispute or difference the parties shall endeavour to resolve the same through conciliatory and amicable measures within 15 Days failing which the matter may be referred by either party for resolution by the sole arbitrator to be appointed mutually by both the parties. The arbitral proceedings shall be conducted in accordance with Arbitration and Conciliation Act 1996 and the place of arbitration shall be Bhubaneswar. The language to be used at proceedings shall be English and the award of the arbitrator shall be final and binding on the parties. The parties shall bear their respective costs of arbitration. The associate shall continue to discharge its obligations towards due performance of the works as per the terms of the contract during the arbitration proceedings unless otherwise directed in writing by TPCODL or suspended by the arbitrator. Further, TPCODL shall continue making such payments as may be found due and payable to the associate for such works.

23.1 Governing Laws and Jurisdiction

The parties shall be subject to the jurisdiction of the courts of law in Bhubaneswar and any matter arising here from shall be subject to applicable law in force in India.

24.0 ATTRIBUTES OF GCC

24.1 Cancellation

The Company reserves the right to cancel, add, delete at its sole discretion, all or any terms of this GCC or any contract, order or terms agreed between the parties in pursuance without assigning any reasons and without any compensation to the Associates.

24.2 Severability

If any portion of this GCC is held to be void, invalid, or otherwise unenforceable, in whole or part, the remaining portions of this GCC shall remain in effect.

24.3 Order of Priority

In case of any discrepancies between the stipulations in General Conditions of the Contract (GCC) and Special Conditions of Contract (SCC), the GCC shall stand superseded by the SCC to the extent stipulated hereinabove while balance portion of respective clauses of GCC shall continue to be applicable.

25.0 ERRORS AND OMISSIONS

The Associate shall be responsible for all discrepancies, errors and omissions in the drawings, documents or other information submitted by him, irrespective of whether these have been approved, reviewed or otherwise accepted by the TPCODL or not. However any error in design/drawing arising out of any incorrect data/written information from TPCODL will not be considered as error and omissions on part of the Associate.

26.0 TRANSFER OF TITLES

The title of ownership and property to all equipment, materials, drawings & documents shall pass to the TPCODL on acceptance of material by store/site after Inspection.

However, such passing of title of ownership and property to the TPCODL shall not in any way absolve, dilute or diminish the responsibility and obligations of the Associate under this Contract including loss or damages and all risks, which shall vest with the Associate.

27.0 INSURANCE

The Contractor shall take out the Insurance Policies which shall cover all risks including the following, as applicable:-

- a) The value of the policy shall cover the total value of all the items till they are handed over to TPCODL.

TP CENTRAL ODISHA DISTRIBUTION LIMITED

(A Tata Power & Odisha Govt. joint venture)

2nd Floor, IDCO Tower, Janpath Bhubaneshwar, Odisha 751022

- b) TPCODL shall be the principal holder of the policy. The Associate shall be the loss payee under the policy. Associate / Sub-contractor of the Associate shall not be holders or beneficiaries in the policy nor shall they be named in the policy. TPCODL reserves the exclusive right to assign the policy.
- c) While the payment of premium may be phased in agreement with the insurance company, at no time shall goods and services required to be provided by the associate shall remain uninsured in accordance with (a) above.
- d) A copy of the Insurance policy shall be made available to TPCODL prior to first dispatch lot of any Equipment and policy shall be kept alive and valid at all times up to the stage of final acceptance.
- e) TPCODL reserves the right to take out whatever policy that is deemed necessary by him if the associate fails to keep the said policy alive and valid at all times and/or causes lapses in payment of premium thereby jeopardizing the said policy. The cost of such policy(s) shall be recovered / deducted from the amount payable to the associate.
- f) The policy shall ensure that the TPCODL's decision regarding replacement of goods damaged, lost or rendered unusable shall be final.

In all cases, the associate shall lodge the claims with the underwriters and also settle the claims and shall also notify TPCODL of any filed claims. However, the associate shall proceed with the repairs and/or replacement of the equipment/components without waiting for the settlement of the claims. In case of seizure of materials by concerned authorities, the associate shall arrange prompt release against bond, security or cash as required. TPCODL, upon request by the associate, will extend all reasonable assistance to the associate in such a case.

All the insurance claims shall be processed and settled by the associate and the missing/damaged items shall be replaced/repared by them without any extra cost to TPCODL and without affecting the completion time.

28.0 SUGGESTIONS & FEEDBACK

We welcome all our Business Associates to write to us about their experience with TPCODL; be it our Company, our services or our people. Each and every concern, issue, query and suggestion from you will help us to become a better company to work with and shall help us develop a strong bonding of trust and a long term relationship with you.

You may send your feedback by filling up our Business Associate Feedback Form enclosed herewith as *Annexure-I*. You can also log on to our website www.tpcentralodisha.com to provide your feedback.

- Suggestions for us
- Feedback form
- Knowledge Sharing/ Experience with TPCODL
- Any issues with TPCODL.

Submission of feedback form is mandatory before the release of final payment to the BA.

29.0 CONTACT POINTS

In case Business Associate needs information with respect to payments or has any grievances, same may be lodged by log on to our website www.tpcentralodisha.com

30.0 LIST OF ANNEXURES

S. No.	Subject	Annexure
1.	Performa for Bid Security Bank Guarantee	A
2.	Performa for Performance Bank Guarantee (CP cum EP)	B
3.	Performa for No Demand Certificate by Associate	C
4.	Performa For Application For Issuance of Consolidated TDS Certificate	D
5.	Business Associate Feedback Form	E
6.	Acceptance Form For Participation In Reverse Auction Event	F
7.	Form for RTGS Payment	G
8.	Vendor Appraisal Form	H
9.	Manufacturer Authorization Form	I

TP CENTRAL ODISHA DISTRIBUTION LIMITED
(A Tata Power & Odisha Govt. joint venture)
2nd Floor, IDCO Tower, Janpath Bhubaneswar, Odisha 751022

ANNEXURE-A

PROFORMA FOR BID SECURITY BANK GUARANTEE

The TP Central Odisha Distribution Limited
Bhubaneswar

WHEREAS, (Name of the Bidder) _____
(hereinafter called "the BIDDER") has submitted his bid dated _____ for the (Name of Contract)
_____ (hereinafter called "the BID").

KNOW ALL men by these presents we (Name of the Bank) _____ of
(Name of the Country) _____ having our registered office
at _____ (hereinafter called "the BANK) are bound unto The TP Central Odisha Distribution
Limited (TPCODL) in the sum of _____ for which payment well and truly to be made to the
TPCODL the Bank binds himself, his successors and assigns by these presents.

SEALED with the Common Seal of the said Bank this _____ day of _____ 20____.

The CONDITIONS of this obligation are:

- i) If the Bidder withdraws his Bid during the period of bid validity specified in the Proforma of Bid or

TP CENTRAL ODISHA DISTRIBUTION LIMITED
(A Tata Power & Odisha Govt. joint venture)
2nd Floor, IDCO Tower, Janpath Bhubaneswar, Odisha 751022

- ii) If the Bidder having been notified of the acceptance of his Bid by the TPCODL during the period of bid validity fails or refuses to furnish the Contract Performance Bank Guarantee, in accordance with the Instructions to Bidders.

We undertake to pay the TPCODL upto the above amount upon receipt of its first written demand, provided that in its demand the TPCODL will note that amount claimed by it is due to it owing to the occurrence of one or both conditions, specifying the occurred condition or conditions.

This Guarantee will remain in force upto and including the date (No of days as mentioned in tender enquiry) days after the closing date of submission of bids as stated in the Invitation to Bid or as extended by you at any time prior to this date, notice of which extension to the Bank being hereby waived, and any demand in respect thereof should reach the Bank not later than the above date.

DATE **SIGNATURE OF THE BANK**

WITNESS **SEAL**

(Signature, Name & Address) (At least 2 witnesses)

ANNEXURE- B

PROFORMA FOR PERFORMANCE BANK GUARANTEE (CP cum EP)

(On Rs.100/- Stamp Paper) Note:

- a) Format shall be followed in toto
b) Claim period of one month must be kept up
c) The guarantee to be accompanied by the covering letter from the bank confirming the signature to the guarantee

The TP Central Odisha Distribution Limited
Bhubaneswar

CP cum EP BG No.....

Order/Contract No.....dated.....

1. You have entered into a Contract No _____ with M/s. _____

TP CENTRAL ODISHA DISTRIBUTION LIMITED
(A Tata Power & Odisha Govt. joint venture)
2nd Floor, IDCO Tower, Janpath Bhubaneswar, Odisha 751022

(hereinafter referred to as “the Vendor”) for the supply cum erection / civil work of _____ (hereinafter referred to as “the said Equipment”) for the price and on the terms and conditions contained in the said contract.

2. In accordance with the terms of the said contract, “the Vendor” agreed to furnish you with an irrevocable, unconditional and acceptable bank guarantee for 10% of the value of contract and to be valid till the end of Guarantee period plus one month towards “Contract cum Equipment performance”. For this purpose you have agreed to accept the guarantee.
3. In consideration thereof, we, _____ hereby irrevocably and unconditionally guarantee to pay to you on demand but in any case before the end of five working days from the date of the claim and without demur and without reference to “the Vendor” such amount or amounts not exceeding the sum of Rs. _____ (Rupees _____ only) being _____% (_____ percent) of the total value of the contract on receipt of your intimating that “the Vendor” has not fulfilled his contractual obligations. You shall be the sole judge for such non-fulfillment and “the Vendor” shall have no right to question such judgment.
4. You shall have the right to file / make your claim on us under the guarantee for a **further period of one month** from the date of expiry.
5. This guarantee shall not be revoked without express consent and shall not be affected by your granting time or any other indulgence to “the Vendor”, which shall include but not be limited to, postponement from time to time of the exercise the same in you or any right which you may have against “the Vendor” and to exercise the same in any covenant contained or implied in the said contract or any other course or remedy or security available to you, and our Bank shall not be released from its obligations under this guarantee by

TP CENTRAL ODISHA DISTRIBUTION LIMITED
(A Tata Power & Odisha Govt. joint venture)
2nd Floor, IDCO Tower, Janpath Bhubaneswar, Odisha 751022

your exercising any of your rights with reference to matters aforesaid or any of them or by reasons of any other act or forbearance or other acts of omission or commission on your part or any other indulgence shown by you or by any other matter or thing whatsoever which under the law would, but for this provision have the effect of relieving our bank from its obligation under this guarantee.

6. We also agree that you shall be entitled at your option to enforce this guarantee against our bank as a principal debtor, in the first instance, notwithstanding any other security or guarantee that you may have in relation to "the Vendor's" liabilities in respect of the premises
7. This guarantee shall not be affected by any change in the constitution of our Bank or "the Vendor" or for any other reason whatsoever.
8. Any claim / extension under the guarantee can be lodge-able at outstation banks or at Bhubaneswar branch and claim will also be payable at Bhubaneswar Branch (to be confirmed by Bhubaneswar Branch by a letter to that effect in case BG is from the branch outside Bhubaneswar).
9. Notwithstanding anything herein contained, our liability under this guarantee is limited to Rs. _____ (Rupees _____) only and the guarantee will remain in force upto and including _____ (Date) and shall be extended from time to time for such period or period as may be desired by "the Vendor".
10. Unless a demand or claim under this guarantee is received by us in writing within one months from _____ (expiry date) i.e. on or before _____ (claim period end date), we shall be discharged from all liabilities under this guarantee thereafter.

Dated at _____ this _____ day of _____ 20__

Bank's rubber stamp

1. Banks full address _____ Designation of Signatory
2. Bank official number _____



NIT No.: TPCODL/P&S/1000000082/2021-22

TP CENTRAL ODISHA DISTRIBUTION LIMITED
(A Tata Power & Odisha Govt. joint venture)
2nd Floor, IDCO Tower, Janpath Bhubaneswar, Odisha 751022

ANNEXURE-C

PROFORMA FOR "NO DEMAND CERTIFICATE" BY ASSOCIATE

(On Company's Letter head or with Company Seal)

(To be submitted by the Associate to TPCODL Accounts Department at the time of receipt of full and final payment)

(Certificate No. CCP/002)

Name of the Project Order/ Contract No.

Dated

Name of the Associate Scheme No. / Job No.

We, M/s. _____ (Associate) do hereby acknowledge and confirm that we have received the full and final payment due and payable to us from TPCODL, in respect of our aforesaid Order No _____ dated _____ including amendments, if any, issued by TPCODL to our entire satisfaction and we further confirm that we have no claim whatsoever pending with TPCODL under the said contract / W.O.

Notwithstanding any protest recorded by us in any correspondence, documents, measurement books and / or final bills etc., we waive all our rights to lodge any claim or protest in future under this contract.

We are issuing this "NO DEMAND CERTIFICATE" in favour of TPCODL, with full knowledge and with our free consent without any undue influence, misrepresentation, coercion etc.

Place

Name

(Company Seal)



NIT No.: TPCODL/P&S/1000000082/2021-22

TP CENTRAL ODISHA DISTRIBUTION LIMITED
(A Tata Power & Odisha Govt. joint venture)
2nd Floor, IDCO Tower, Janpath Bhubaneswar, Odisha 751022

ANNEXURE-D

PROFORMA FOR APPLICATION FOR ISSUANCE OF CONSOLIDATED TDS CERTIFICATE

To be printed on the letterhead

To,

The TP Central Odisha Distribution Limited
Bhubaneswar

Sub: Application for issuance of Consolidated TDS Certificate for the FY _____

Dear Sir,

I / we hereby request / authorize you to issue me / us a consolidate TDS Certificate for the financial year _____ against tax deducted at source by you from my / our payments / bills during the said year from time to time under Chapter XVII – B of the Income Tax Act, 1961. For and on behalf of

Signature

Name

Address

Contact No. (Land Line)

(Mobile)

PAN #

Assessing authority

ATTACH THE COPY OF PAN CARD

TP CENTRAL ODISHA DISTRIBUTION LIMITED
(A Tata Power & Odisha Govt. joint venture)
2nd Floor, IDCO Tower, Janpath Bhubaneswar, Odisha 751022
ANNEXURE-E

BUSINESS ASSOCIATE FEEDBACK FORM

With an objective to improve our internal processes and systems, and serve you better, we solicit your valuable feedback & suggestions. It is estimated that it will take about 10 minutes to complete this survey. We assure you that your feedback shall be kept confidential. Please send the duly filled feedback form in the "TPCODL addressed - attached envelop"

You are associated with us as

- OEMs Service Contractor Material Suppliers Material & Manpower Supplier

You are associated with us for

- Less than 1 year More than 1 year but less than 3 years More than 3 years

Your office is located at

- Bhubaneswar Within 200 kms from Bhubaneswar More than 200 kms from Bhubaneswar

Your nearly turnover with TPCODL

- Less than 25 Lacs 25 Lacs to 1 Crore More than 1 Cr.

Additional Information

Your Name	
Your Designation	
Your Organization	
Contact Nos.	
Email	

TP CENTRAL ODISHA DISTRIBUTION LIMITED
 (A Tata Power & Odisha Govt. joint venture)
 2nd Floor, IDCO Tower, Janpath Bhubaneswar, Odisha 751022

We once again thank you for your participation in this survey. Please spare 10 minutes to give your feedback on following pages (Section A to E)

SECTION – A

(Please ✓ mark in the relevant box and give your remarks / suggestions / information for our improvement).

S. No.	Parameters	1	2	3	4	5	Remarks/ Suggestion
		Do Not Agree	Slightly in Agreement	In Fair Agreement	Mostly in Agreement	Fully Agree	
1	You receive all relevant queries / tenders from us in timely manner.						
2	We provide you enough lead time to respond to our queries / tenders.						
3	We provide you adequate support (drawings, documents, clarifications, briefing etc.) to enable you meet our requirements.						
4	All following elements of our contract / purchase order are rational :						
4.1	Scope of Work						
4.2	Delivery / Execution Schedule						
4.3	Payment Terms						
4.4	Liquidated Damages						
4.5	Performance Guarantee						
5	Our purchase orders / contracts are simple, specific & easy to understand						
6	TPCODL demonstrate willingness to be flexible in administration of Contract / Purchase Order						
7	We provide timely responses / clarifications to your queries						
8	TPCODL representative you interact / coordinate with is adequately empowered to support you in meeting contractual obligations						
9	TPCODL provide you all necessary infrastructure support for timely and quality completion of work (including AMC)						

TP CENTRAL ODISHA DISTRIBUTION LIMITED
 (A Tata Power & Odisha Govt. joint venture)
 2nd Floor, IDCO Tower, Janpath Bhubaneshwar, Odisha 751022

S. No.	Parameters	1	2	3	4	5	Remarks/ Suggestion
		Do Not Agree	Slightly in Agreement	In Fair Agreement	Mostly in Agreement	Fully Agree	
10	TPCODL Engineer-in-Charge timely certifies the jobs executed/ material supplied						
11	TPCODL Engineer-in-Charge efficiently supervises the job execution for timely completion of job						
12	BIRD (Bill Inward Receipt Desk) initiative has improved payment disbursement process						
13	Our approach for Inspection and Quality Assurance effective to expedite project completion?						
14	TPCODL never defaults on contractual terms						
15	In TPCODL Contracts closure is done within set time limit						
16	Our material receiving procedures are well defined and efficiently deployed to reduce mutual inconvenience						
17	Bank Guarantees are released in time bound manner						
18	Our processes related to payment / account settlement are effective.						
19	You get payments on time						
20	TPCODL Employees follow Ethical behaviour						

TP CENTRAL ODISHA DISTRIBUTION LIMITED
 (A Tata Power & Odisha Govt. joint venture)
 2nd Floor, IDCO Tower, Janpath Bhubaneswar, Odisha 751022

SECTION – B

SECTION – B (Please rate the following parameters on a scale of 1 to 5, where 1 - Minimum; 5 - Maximum)

S. No.	Parameters	1	2	3	4	5	Remarks/ Suggestion
1	How do you rate courtesy/ empathy/ attitude level and warmth of TPCODL employees you interact with from following team?						
1.1	Project Engineering						
1.2	District / Zones						
1.3	Projects/HOG (TS &P)						
1.4	Inspection & Quality Assurance						
1.5	Stores						
1.6	Metering & Billing						
1.7	Accounts / Finance						
1.8	Administration						
1.9	IT & Automation						
2	How would you rate TPCODL in comparison to your other clients in terms of fairness of treatment and transparency with its Business Associates?						
3	How would you rate TPCODL in comparison to your other clients in terms of processes and systems to manage partnership with its Business Associates						
4	How would you rate TPCODL in comparison to your other clients in terms of building long term & mutually relationship with its Business Associates						

TP CENTRAL ODISHA DISTRIBUTION LIMITED
 (A Tata Power & Odisha Govt. joint venture)
 2nd Floor, IDCO Tower, Janpath Bhubaneswar, Odisha 751022

SECTION – C

Please ✓ mark in the relevant box and give your remarks / suggestions / information for our improvement.

S. No.	Parameters	Certainly No	Probably No	Certainly Yes	Probably Yes	Remarks/ Suggestion
1	Based on your experience with TPCODL, would you like to continue your relationship with TPCODL?					
2	If someone asks you about TPCODL, would you talk “positively” about TPCODL?					
3	Would you refer TPCODL name to others in your community, fraternity and society as a professional & dynamic organization?					

SECTION - D

If we ask you to rate us on a scale of 1 to 10, how will you rate TPCODL, that truly represents your overall satisfaction with us (please tick appropriate box) -

1	2	3	4	5	6	7	8	9	10
---	---	---	---	---	---	---	---	---	----

SECTION – E

Please v mark in the relevant box and give your remarks / suggestions / information for our improvement.

Please spare your thoughts for TPCODL’s improvement in particular areas of weaknesses, particularly relating to some great practices, attitudes that you have seen elsewhere in Indian and International Organizations, which you recommend TPCODL to adopt. Please give your valuable salient recommendations.

Please spare your thoughts for TPCODL’s improvement in particular areas of major concerns for you. We also welcome your suggestions to adopt any best practices, attitudes that you

Recommendation	<i>Please tick (v) your top 5 expectations out of the following 10 points listed below -</i>	
(Please list down improvement you expect from TPCODL)	<i>Timely payment</i>	
1	<i>Flexibility in Contracts/PO</i>	
	<i>Clarity in PO,s & Contracts</i>	
2	<i>Timely response to quarries</i>	
	<i>Timely certification of works executed</i>	
3	<i>Clarity in Specs, drawings, other docs etc.</i>	
	<i>Adequate information provided on website for tender notification, parties qualified etc.</i>	
4	<i>Timely receipt of material at site for execution</i>	
	<i>Performance Guarantee/EMD released in time</i>	
5	<i>Inspection & quality assurance support for timely job completion</i>	

We thank you for your time and courtesy!!

ANNEXURE-F

ACCEPTANCE FORM FOR PARTICIPATION IN REVERSE AUCTION EVENT

(To be signed and stamped by the bidder prior to participation in the auction event)

In a bid to make our entire procurement process more fair and transparent, TPCODL intends to use the reverse auctions through SAP-SRM tool as an integral part of the entire tendering process. All the bidders who are found as technically qualified based on the tender requirements shall be eligible to participate in the reverse auction event.

The following terms and conditions are deemed as accepted by the bidder on participation in the bid event:

1. TPCODL shall provide the user id and password to the authorized representative of the bidder. (Authorization Letter in lieu of the same shall be submitted along with the signed and stamped Acceptance Form).
2. TPCODL will make every effort to make the bid process transparent. However, the award decision by TPCODL would be final and binding on the supplier.
3. The bidder agrees to non-disclosure of trade information regarding the purchase, identity of TPCODL, bid process, bid technology, bid documentation and bid details.
4. The bidder is advised to understand the auto bid process to safeguard themselves against any possibility of non-participation in the auction event.
5. In case of bidding through Internet medium, bidders are further advised to ensure availability of the entire infrastructure as required at their end to participate in the auction event. Inability to bid due to telephone line glitch, internet response issues, software or hardware hangs, power failure or any other reason shall not be the responsibility of TPCODL.
6. In case of intranet medium, TPCODL shall provide the infrastructure to bidders. Further, TPCODL has sole discretion to extend or restart the auction event in case of any glitches in infrastructure observed which has restricted the bidders to submit the bids to ensure fair & transparent competitive bidding. In case an auction event is restarted, the best bid as already available in the system shall become the start price for the new auction.
7. In case the bidder fails to participate in the auction event due any reason whatsoever, it shall be presumed that the bidder has no further discounts to offer and the initial bid as submitted by the bidder as a part of the tender shall be considered as the bidder's final no regret offer. Any offline price bids received from a bidder in lieu of non-participation in the auction event shall be out rightly rejected by TPCODL.
8. The bidder shall be prepared with competitive price quotes on the day of the bidding event.
9. The prices as quoted by the bidder during the auction event shall be inclusive of all the applicable taxes, duties and levies and shall be FOR at TPCODL site.
10. The prices submitted by a bidder during the auction event shall be binding on the bidder.
11. No requests for time extension of the auction event shall be considered by TPCODL.
12. The original price bids of the bidders shall be reduced on pro-rata basis against each line item based on the final all inclusive prices offered during conclusion of the auction event for arriving at Contract amount.

Signature & Seal of the Bidder



NIT No.: TPCODL/P&S/100000082/2021-22

TP CENTRAL ODISHA DISTRIBUTION LIMITED
(A Tata Power & Odisha Govt. joint venture)
2nd Floor, IDCO Tower, Janpath Bhubaneswar, Odisha 751022

ANNEXURE-G

To,

DGM (Finance) (Resource)

The TP Central Odisha Distribution Limited

Bhubaneswar

**Sub: e-Payments through National Electronic Fund Transfer (NEFT) OR Real Time
Gross Settlement System (RTGS)**

Dear Sir,

We request and authorize you to affect e-payment through NEFT/RTGS to our Bank Account as per the details given below:-

Vendor Code :

Title of Account in the Bank :

Account Type :

(Please mention here whether account is Savings/Current/Cash Credit)

Bank Account Number :

--	--	--	--	--	--	--	--	--	--	--	--	--	--	--	--	--	--	--	--	--

Name & Address of Bank :

Bank Contact Person's Names :

Bank Tele Numbers with STD Code :

Bank Branch MICR Code :

--	--	--	--	--	--	--	--	--	--	--	--	--	--	--	--	--	--	--	--	--

(Please enclose a Xerox a copy of a cheque. This cheque should not be a payable at par cheque)



NIT No.: TPCODL/P&S/1000000082/2021-22

TP CENTRAL ODISHA DISTRIBUTION LIMITED
(A Tata Power & Odisha Govt. joint venture)
2nd Floor, IDCO Tower, Janpath Bhubaneswar, Odisha 751022

Bank Branch IFSC Code

:

--	--	--	--	--	--	--	--	--	--	--	--	--	--	--	--	--	--	--	--

(You can obtain this from branch where you have your account)

Email Address of accounts person: (to send payment information) :

Name of the Authorized Signatory: :

Contact Person's Name: :

Official Correspondence Address: :

We confirm that we will bear the charges, if any, levied by our bank for the credit of NEFT/RTGS amounts in our account. Any change in above furnished information shall be informed to TPCODL well in time at our own. Further, we kept TPCODL indemnified for any loss incurred due to wrong furnishing of above information.

Thanking you,

For _____

(Authorised Signatory)

(Signature with Rubber Stamp)

Certification from Bank:

We confirm that we are enabled for receiving NEFT/RTGS credits and we further confirm that the account number (specify Bank a/c no.) of (Please mention here name of the account holder), the signature of the authorised signatory and the MICR and IFSC Code of our branch mentioned above are correct.

This also is certified that the above information is correct as per Bank record

(Manager's/ Officers Signature under Bank Stamp)



NIT No.: TPCODL/P&S/100000082/2021-22

TP CENTRAL ODISHA DISTRIBUTION LIMITED
(A Tata Power & Odisha Govt. joint venture)
2nd Floor, IDCO Tower, Janpath Bhubaneshwar, Odisha 751022

ANNEXURE-H

VENDOR APPRAISAL FORM

TO BE SUBMITTED BY VENDOR (To be filled as applicable)			
VENDOR:			
1.0	DETAILS OF THE FIRM		
	1.1	NAME (IN CAPITAL LETTERS)	:
	1.2	TYPE OF CONCERN (PROPRIETARY) Partnership, Pvt. Ltd., Public Ltd. etc.	:
	1.3	YEAR OF ESTABLISHMENT	:
	1.4	LOCATION OF OFFICE POSTAL ADDRESS TELEGRAPHIC ADDRESSES, TELEX NO. FAX NO.	:
	1.5	LOCATION OF MANUFACTURING UNITS	:
		i) UNITS 1	:
		ii) OTHER UNITS	:
2.0	PRODUCTS MANUFACTURED		
3.0	TURNOVER DURING THE LAST 3 YEARS (TO BE VERIFIED WITH THE LATEST PROFIT & LOSS STATEMENT).		
4.0	VALUE OF FIXED ASSETS		
5.0	NAME & ADDRESS OF THE BANKERS		
6.0	BANK GUARANTEE LIMIT		
7.0	CREDIT LIMIT		
8.0	TECHNICAL		
	8.1	NO. OF DESIGN ENGINEERS (INDICATE NO. OF YEARS EXPERIENCE IN RELATED FIELDS)	:
	8.2	NO. OF DRAUGHTS MEN	:
	8.3	COLLABORATION DETAILS (IF ANY)	:
		8.3.1 DATE OF COLLABORATION	:



NIT No.: TPCODL/P&S/100000082/2021-22

TP CENTRAL ODISHA DISTRIBUTION LIMITED
 (A Tata Power & Odisha Govt. joint venture)
 2nd Floor, IDCO Tower, Janpath Bhubaneswar, Odisha 751022

	8.3.2	NAME OF COLLABORATOR	:
	8.3.3	RBI APPROVAL DETAILS	:
	8.3.4	EXPERIENCE LIST OF COLLABORATOR	:
	8.3.5	DURATION OF AGREEMENT	:
	8.4	AVAILABILITY OF STANDARDS / DESIGN PROCEDURES / COLLABORATOR'S / DOCUMENTS (CHECK WHETHER THESE ARE LATEST/CURRENT	:
	8.5	TECHNICAL SUPPORT, BACK-UP GUARANTEE, SUPERVISION, QUALITY CONTROL BY COLLABORATOR (WHEREVER ESSENTIAL). (THIS CLAUSE IS RELEVANT WHEN VENDOR'S EXPERIENCE IS INADEQUATE)	:
	8.6	QUALITY OF DRAWINGS	:
9.0	MANUFACTURE		
	9.1	SHOP SPACE, LAYOUT LIGHTING, VENTILATION, ETC.	:
	9.2	POWER (KVA)	:
		MAINS INSTALLED	:
		UTILIZED	:
		STANDBY POWER SOURCE	:
	9.3	MANUFACTURING FACILITIES (ATTACH LIST OF EQUIPMENT AS APPLICABLE)	:
		9.3.1 MATERIAL HANDLING	:
		9.3.2 MACHINING	:
		9.3.3 FABRICATION	:
		9.3.4 HEAT TREATMENT	:
		9.3.5 BALANCING FACILITY	:
		9.3.6 SURFACE TREATMENT PRIOR TO PAINTING/ COATING, POLISHING, PICKLING, PASSIVATION, PAINTING, ETC.	:
	9.4	SUPERVISORY STAFF	:
	9.5	ADEQUACY OF SKILLED LABOURS (MACHINISTS, WELDERS, ETC.)	:
	9.6	NO. OF SHIFTS	:



NIT No.: TPCODL/P&S/100000082/2021-22

TP CENTRAL ODISHA DISTRIBUTION LIMITED
 (A Tata Power & Odisha Govt. joint venture)
 2nd Floor, IDCO Tower, Janpath Bhubaneswar, Odisha 751022

	9.7	TYPE OF MATERIAL HANDLED (SUCH AS CS, SS, ETC.)	
	9.8	WORKMANSHIP	:
	9.9	MATERIAL IN STOCK AND VALUE	:
	9.10	TRANSPORT FACILITIES	:
	9.11	CARE IN HANDLING	:
10.0	INSPECTION / QC / QA / TESTING		
	10.1	NUMBER OF PERSONNEL (INDICATE NO. OF YEARS OF EXPERIENCE)	:
	10.2	INDEPENDENCE FROM PRODUCTION	:
	10.3	AVAILABILITY OF PROCEDURAL WRITE UP/QUALITY PLAN	:
	10.4	INCOMING MATERIAL CONTROL AND DOCUMENTATION	:
	10.5	RELIABILITY/REPUTATION OF SUPPLY SOURCES	:
	10.6	STAGE INSPECTION AND DOCUMENTATION	:
	10.7	SUB-ASSEMBLY & DOCUMENTATION	:
	10.8	FINAL INSPECTION AND DOCUMENTATION	:
	10.9	PREPARATION OF FINAL DOCUMENTATION PACKAGE	:
	10.10	TYPE TEST FACILITIES	:
	10.11	ACCEPTANCE TEST FACILITIES	:
	10.12	CALIBRATION OF INSTRUMENTS AND GAUGES (WITH TRACEABILITY TO NATIONAL STANDARDS) (ATTACH LIST)	:
	10.13	STATUTORY APPROVALS LIKE BIS, IBR, ETC.(AS APPLICABLE)	:
	10.14	SUB-VENDOR APPROVAL SYSTEM AND QUALITY CONTROL	:
	10.15	DETAILS OF TESTS CARRIED OUT AT INDEPENDENT RECOGNIZED LABORATORIES	:
		i) FURNISH LIST OF TESTS CARRIED OUT AND THE NAME OF THE LABORATORY WHERE THE TESTS WERE CONDUCTED	:
		ii) CHECK AVAILABILITY OF CERTIFICATES AND REVIEW THESE WHEREVER POSSIBLE	:
11.0	EXPERIENCE (INCLUDING CONSTRUCTION / ERECTION / COMMISSIONING) TO BE FURNISHED IN THE FORMAT INDICATED IN APPENDIX)		



NIT No.: TPCODL/P&S/100000082/2021-22

TP CENTRAL ODISHA DISTRIBUTION LIMITED

(A Tata Power & Odisha Govt. joint venture)

2nd Floor, IDCO Tower, Janpath Bhubaneswar, Odisha 751022

12.0	SALES, SERVICE AND SITE ORGANIZATIONAL DETAILS	:
13.0	CERTIFICATE FROM CUSTOMERS (ATTACH COPIES OF DOCUMENTS)	:
14.0	POWER SITUATION	:
15.0	LABOUR SITUATION	:
16.0 *	APPLICABILITY OF SC/ST RELAXATION (Y/N) IF YES, SUPPORTING DOCUMENTS TO BE ATTACHED	
17.0	ORGANIZATIONAL DETAILS 1. PF NO 2. ESI NO 3. INSURANCE FOR WORK MAN COMPENSATION ACT NO 4. ELECTRICAL CONTRACT LIC NO 5. ITCC / PAN NO 6. SALES TAX NO 7. WC TAX REG. NO	:
18.0	DOCUMENTS TO BE ENCLOSED: 1. FACTORY LICENSE 2. ANNUAL REPORT FOR LAST THREE YEARS 3. TYPE TEST REPORT FOR THE ITEM 4. PAST EXPERIENCE REPORTS 5. ISO CERTIFICATE –QMS, EMS, OHAS, SA 6. REGISTRATION OF SALES TAX 7. COPY OF TIN NO. 8. COPY OF SERVICE TAX NO. 9. REGISTRATION OF CENTRAL EXCISE 10. COPY OF INCOME TAX CLEARANCE. 11. COPY OF PF REGISTRATION 12. COPY OF ESI REGISTRATION 13. COPY OF INSURANCE FOR WORK MAN COMPENSATION ACT NO 14. COPY OF ELECTRICAL CONTRACT LIC NO 15. COPY OF PAN NO 16. COPY OF WC TAX REGISTRATION 17. DOCUMENTS IN SUPPORT OF SC/ST RELAXATION AT S.NO.16.0 18. GSTN CERTIFICATE	

* Classification of BA s under SC/ST shall be governed under following guidelines:

- **Proprietorship/ Single Ownership Firm:** Proprietor of the firm should be from SC/ST community. Governing document shall be Proprietorship Deed.
- **Partnership Firm:** Only such firms shall qualify which have SC/ST partners holding equal to or more than 50% of the total ownership pattern of the firm. Governing document shall be Partnership Deed.



NIT No.: TPCODL/P&S/100000082/2021-22

TP CENTRAL ODISHA DISTRIBUTION LIMITED

(A Tata Power & Odisha Govt. joint venture)

2nd Floor, IDCO Tower, Janpath Bhubaneswar, Odisha 751022

- **Private Limited Company:** Only such firms shall qualify which have SC/ST directors holding equal to or more than 50% of the total ownership pattern of the firm. Governing document shall be Memorandum of Understanding (MoU) and/or Article of Association (AoA).

NOTE: Certification from SC/ST Commission shall be required for deciding upon SC/ST status of a person.

ANNEXURE-I

MANUFACTURER AUTHORIZATION FORM

(To be submitted on OEM's Letter Head)

Date:

Tender Enquiry No.:

To,

Chief (Procurement & Stores)

The TP Central Odisha Distribution Limited

Bhubaneswar

Sir,

WHEREAS M/s. *[name of OEM]*, who are official manufacturers of having factories at *[address of OEM]* do hereby authorize M/s *[name of bidder]* to submit a Bid in relation to the Invitation for Bids indicated above, the purpose of which is to provide the following Goods, manufactured by us

.....and to subsequently negotiate and sign the Contract.

We hereby extend our full guarantee and warranty in accordance with the Special Conditions of Contract or as mentioned elsewhere in the Tender Document, with respect to the Goods offered by the above firm in reply to this Invitation for Bids.

We hereby confirm that in case, the channel partner fails to provide the necessary services as per the Tender Document referred above, M/s *[name of OEM]* shall provide standard warranty on the materials supplied against the contract. The warranty period and inclusion / exclusion of parts in the warranty shall remain same as defined in the contract issued to their channel partner against this tender enquiry.

Yours Sincerely,

For

Authorized Signatory



NIT No.: TPCODL/P&S/1000000082/2021-22

TP CENTRAL ODISHA DISTRIBUTION LIMITED
(A Tata Power & Odisha Govt. joint venture)
2nd Floor, IDCO Tower, Janpath Bhubaneshwar, Odisha 751022

ANNEXURE IX

SAFETY POLICY AND SAFETY TERMS AND CONDITIONS

Definitions

Order Manager: Order Manager is the TPCODL representative, who has the ownership of the given job under the signed contract.

Service Provider/Contractor/Vendor: An individual or an organization that provides services to TPCODL under a signed contract.

Site Safety Management Plan: It is the safety plan agreed between Contractor / Service provider and TPCODL. It will contain the entire job specific safety requirement and will be signed by the service provider.

High Risk Job: Any job which has significant health and safety risk associated to it. The list of high risk jobs has been identified at TPCODL level.

Emergency: A serious, unexpected, business discontinuity and often dangerous situation resulting into loss of revenue / property and requiring immediate action.

TP CENTRAL ODISHA DISTRIBUTION LIMITED

(A Tata Power & Odisha Govt. joint venture)

2nd Floor, IDCO Tower, Janpath Bhubaneswar, Odisha 751022

1. Safety Policy



HEALTH AND SAFETY POLICY

Tata Power is committed to provide safe and healthy working environment for the prevention of work related injuries and ill-health. Safety is one of our core values. We strive to be a leader in safety excellence in the global power and energy business. In pursuit of this, we are committed to the following:

- Maintain and continually improve our management systems to eliminate hazards and reduce health & safety risks to all our stakeholders.
- Incorporate appropriate health & safety criteria into business decisions for selection of plant and technology, performance appraisal of individuals and appointments in key positions.
- Comply and endeavour to exceed all applicable health & safety legal and other requirements
- Integrate health & safety procedures and best practices into every operational activity with assigned line-functional responsibilities at all levels.
- Involve our employees and business associates in maintaining a safe and healthy work environment through consultation and participation
- Inculcate safety culture by visible leadership and empowerment.
- Ensure required competency to enable our employees and business associates for working safely.
- Promptly report incidents, investigate, share crucial learnings and prevent recurrences.
- Influence our business associates in enhancing their health and safety standards and align with Tata Power's health & safety codes and practices.
- Set safety & health metrics as indicators of excellence, monitor progress and continually improve health and safety performance.

We shall ensure the availability of appropriate resources at all times to fully implement and communicate this policy to all stakeholders by suitable means and periodically review its relevance in continuously changing business environment.

(Praveer Sinha)
CEO & Managing Director

Date: 11th March, 2019
TATA POWER
Lighting up Lives!





NIT No.: TPCODL/P&S/100000082/2021-22

TP CENTRAL ODISHA DISTRIBUTION LIMITED

(A Tata Power & Odisha Govt. joint venture)

2nd Floor, IDCO Tower, Janpath Bhubaneswar, Odisha 751022

2. Safety Organization & Responsibilities

2.1 Contractor Site Management and Supervision

Each Contractor will be responsible for fulfilling all statutory and safety requirements as per the laws of the land and not limited to Factory Act, Electricity Act, Electricity Rules and Regulations, Shop and Establishment Act etc.

Each Contractor shall provide at least one competent full time safety supervisor for workforce of less than 100 numbers. When workforce ranges from 100 to 1000, the contractor has to provide at least one qualified safety officer and safety supervisors (reporting to the safety officer) in the ratio 1:100. For every 1000 addition in workforce, the contractor has to add 1 safety officer. The TPCODL Project Safety Manager will review and approve the appointment of all safety supervisors. Contractor/Subcontractor safety supervisors/officers will work with Tata Power Safety Managers and align themselves with Tata Power safety requirements.

Each Contractors'/Subcontractors' Site Manager is responsible, and will be held accountable, for the safety of their sub-contractors and workforce and for ensuring that all equipment, materials, tools and procedures remain in safety compliance at job site, including:

- Holding officer/supervisors accountable for safety and actively promote safe work performance.
- Participate in and cooperate with all safety program requirements to be implemented in order to meet Tata Power safety objectives.
- Ensure timely reporting of safety incidents, near misses, unsafe acts and conditions.
- Identify the training needs of its employees and maintain all safety training documents.
- Provide safety performance report at an agreed frequency.
- Stopping of unsafe work (acts and/or conditions) immediately, until corrective action be taken.

2.2 Contractor Supervisors and General Staff

Contractors' site supervisors and general staff members in charge of job site functions such as field engineering, warehousing, purchasing, cost and scheduling, etc. are responsible for the safe performance of the work of those they supervise. They must set an example for their fellow employees by being familiar with applicable sections of the Site Safety program and ensuring that all site activities are performed with SAFETY as the primary objective.

Each site supervisor is responsible and will be held accountable for identifying, analyzing and eliminating or controlling all hazards through implementation of an aggressive, pro-active Health, Safety and Environmental Program from project inception through project completion. Each supervisor will proactively participate in the SHE program by observing, correcting unsafe acts, and recording these observations.

2.3 Contractor Workforce

Contractor workforce must make safety a part of their job by following safety rules and regulations and by using all safeguards and safety equipment. They must take an active part in the Site Safety program to ensure their own safety and injury-free employment as well as being alert to unsafe practices of their fellow employees.

Every member of the workforce is expected to report for work without influence of any Drug/Alcohol. All employees are expected to report any hazardous conditions practices and behaviors in their work areas and correct where ever possible. Workforce is responsible for active participation in safety and health programs, suggestion systems, and trainings and in immediate reporting of all injuries, any unsafe practices, conditions or incidents to their supervisors.



NIT No.: TPCODL/P&S/100000082/2021-22

TP CENTRAL ODISHA DISTRIBUTION LIMITED

(A Tata Power & Odisha Govt. joint venture)

2nd Floor, IDCO Tower, Janpath Bhubaneswar, Odisha 751022

2.4 Vendor/Contractor

Vendors/Contractor shall at all times comply with, and ensure that their workforce comply with all site safety rules and regulations. Specifically, with applicable provisions of the Tata Power Site Safety Management Plan, and all statutory safety rules and regulations.

3. Site Safety Rules and Procedures

The work in the safest possible manner can only happen when it has been carefully planned and all applicable procedures are followed. The Tata Power Safety Procedures are derived from Tata Power best practices and the applicable Government acts regulations. In each case, the most stringent regulation is used.

Following is the list of Tata Power's critical Safety Rules and Procedures. Contractor shall refer to approved Rules and Procedures for detailed requirements and ensure conformance.

3.1 Lock Out and Tag Out Procedure

This procedure is intended to be used for the protection of Personnel while servicing or performing maintenance on equipment / pipeline / vessel / process systems. This is a general procedure that shall be used as the minimum requirements for isolation of equipment, pipelines, machines, system from all possible sources of hazardous energy and / or material such as Steam, Hot Water, Compressed Air, any other process fluid / chemical energy/Mechanical energy or Electrical energy. For complete procedure kindly refer Procedure Document No. TPSMS/CSP/LOTO/001 REV 01 available on official website of Tata Power (www.tatapower.com)

3.2 Excavation Safety (Shoring and Sloping) Procedure

This procedure is developed to cover the safe practices required for shoring and sloping in excavation and trenching jobs. This procedure is developed to establish mandatory requirements for practices to protect personnel, property and equipment from hazards associated with above activities. For complete procedure kindly refer Procedure Document No TPSMS/CSP/EXS/002 REV 01 available on official website of Tata Power (www.tatapower.com)

3.3 Confined Space Entry Procedure

This procedure outlines the steps required to perform the confined space entry and to protect personnel from the hazards of entering and conducting operations in confined spaces. For complete procedure kindly refer Procedure Document No –TPSMS/CSP/CSE/003 REV 01 available on official website of Tata Power (www.tatapower.com)

3.4 Working at Height Procedure

This procedure describes the rules and procedures to protect employees from the hazards of working at heights.

This procedure is developed to cover the safe practices required for Working at Heights. This procedure is developed to establish mandatory requirements for practices to protect personnel from hazards associated in this area. For complete procedure kindly refer Procedure Document No –TPSMS/CSP/WAH/004 REV 01 available on official website of Tata Power (www.tatapower.com)

3.5 Heavy Equipment Movement Safety Procedure



NIT No.: TPCODL/P&S/100000082/2021-22

TP CENTRAL ODISHA DISTRIBUTION LIMITED

(A Tata Power & Odisha Govt. joint venture)

2nd Floor, IDCO Tower, Janpath Bhubaneshwar, Odisha 751022

Heavy equipment lifting and movement is an activity involving loading, unloading, storage and movement from one place to another including lifting and erection or repairing of equipment with cranes or hoists. Material, machinery and equipment handling operations are being carried out by large capacity cranes and hoists, which make the job safer and faster. This procedure addresses the hazards and precautions associated with such equipment and their use. For complete procedure kindly refer Procedure Document No –TPSMS/CSP/HEMS/005 REV 01 available on official website of Tata Power (www.tatapower.com)

3.6 Mobile Crane Safety Procedure

Mobile cranes are responsible for many incidents, injuries. Falling loads from mobile cranes pose a severe hazard to operators and nearby workers and property. Many types of cranes, hoists, and rigging devices are used for lifting and moving materials. To maintain safe, appropriate standards has to be adhered to and only qualified and licensed individuals shall operate these devices. For complete procedure kindly refer Procedure Document No –TPSMS/CSP/MCS/006 REV 01.

3.7 Scaffold Safety Procedure

This procedure is developed to provide information on the safe erection, use, dismantling and maintenance of access scaffolding in the workplace. It is developed to establish mandatory requirements for practices to protect personnel from hazards associated with erection, use and dismantling of scaffolds. For complete procedure kindly refer Procedure Document No – TPSMS/CSP/SCAF/007 REV 01 available on official website of Tata Power (www.tatapower.com)

3.8 Electrical Safety Procedure

The objective of these standards is to specify minimum mandatory requirements and advisory guidance for identifying and controlling hazards to ensure 'Zero Harm' with regard to operation maintenance and testing of electrical equipment. For complete procedure kindly refer Procedure Document No- TPSMS/CSP/ELEC/010 REV 01 available on official website of Tata Power (www.tatapower.com)

3.9 Job Safety Analysis (JSA) Procedure

This objective of this procedure is to have a task based risk assessment process in place that identifies, evaluates and controls the risks associated with work activities, and as a result, prevents those involved in the task or those potentially affected by the task, from being harmed. For complete procedure kindly refer Procedure Document No- TPSMS/CSP/JSA/009 REV 01 available on official website of Tata Power (www.tatapower.com)

3.10 Fire Safety Management Procedure

Objective of This standard is to specify the minimum mandatory requirements and advisory guidelines to ensure prevention of fire related incidents and managing / controlling their impacts if they do occur. For complete procedure kindly refer Procedure Document No- TPSMS/CSP/FSM/011 REV 01

3.11 Permit To Work Procedure

Given the inherent hazards of the power generation and distribution industry, a significant number of TATA POWER operations and installations are critical. Work Permit (WP) System is an essential element in controlling the workplace risks in an effective manner. For complete procedure kindly refer Procedure Document No –TPSMS/CSP/PTW/008 REV 01 available on official website of Tata Power (www.tatapower.com)



NIT No.: TPCODL/P&S/100000082/2021-22

TP CENTRAL ODISHA DISTRIBUTION LIMITED

(A Tata Power & Odisha Govt. joint venture)

2nd Floor, IDCO Tower, Janpath Bhubaneswar, Odisha 751022

3.12 Lift (Elevator) Safety Procedure

To provide safe operating procedure for taking control of lift car before entering and existing the pit of OTIS make elevators. For complete procedure kindly refer Procedure Document No – TPSMS/GSP/LIFT/001 REV 01 available on official website of Tata Power (www.tatapower.com)

3.13 Working on conveyor belt Procedure

This procedure is developed to cover the safe practices required for Working on live equipment and to protect personnel from hazards associated with it. For complete procedure kindly refer Procedure Document No – TPSMS/GSP/CONV/002 REV 01 available on official website of Tata Power (www.tatapower.com)

3.14 Handling Hazardous Materials Procedure

This Procedure is developed to provide procedure for recycling and / or safe disposal of used / waste batteries in compliance with all legislation. For complete procedure kindly refer Procedure Document No-TPSMS/GSP/HAZM/003 REV 01 available on official website of Tata Power (www.tatapower.com)

3.15 Material Handling and Storage Procedure

The purpose of this document is to provide procedures to assist the safe handling of materials (manual handling and mechanical handling). For complete procedure kindly refer Procedure Document No – TPSMS/GSP/MATL/004 REV 01 available on official website of Tata Power (www.tatapower.com)

3.16 Contractor Safety Management Procedure

The purpose of this document is to engage with contractors in a way to create safe work environment for everyone working for Tata Power. For complete procedure kindly refer Procedure Document No – TPSMS/GSP/CSM/015 REV 01 available on official website of Tata Power (www.tatapower.com)

The above procedures will be updated periodically and the updated version of the procedures as well as any additional critical procedure will be available on official website of Tata Power (www.tatapower.com) for your reference.

4. Training and Capability Building

Safety Training and capability building of workforce is a major component of safety management program. All training required must be provided and documented as specified by Tata Power and Indian Regulations. Tata Power Safety Manager will audit contractors training and related documentation to assure its adequacy.

4.1 Tata Power Site Safety Orientation

All Tata Power contractor and subcontractor workforce is required to attend Tata Power Site Safety Orientation Training to receive a Safety Training Card, which is required to obtain a Gate Pass to the site, prior to entry.

This Safety Orientation Course will be for duration of minimum half day. The information provided during the orientation will include, but is not limited to following:

- Job rules, personal safety and conduct
- Hazards reporting
- Reporting of injuries



TP CENTRAL ODISHA DISTRIBUTION LIMITED
(A Tata Power & Odisha Govt. joint venture)
2nd Floor, IDCO Tower, Janpath Bhubaneshwar, Odisha 751022

- Emergency procedures
- Safety Activities and Program including disciplinary measure and incentives.
- Critical safety procedure relevant to the job

4.2 Capability Building

Appropriate training such as L1, L2 & L3 is given to ensure that a jobholder, either supervisor or worker, is competent to do his/her job safely. The skill training is provided through TPSDI and other agencies authorized by Tata Power on the list of 15 procedures mentioned under safety procedure.

Contractor shall ensure that concerned workmen are provided with adequate training before he/she is allowed to execute the work.

An evaluation test will be conducted after the completion of the training. Those workmen employee who meet the minimum required competency will be provided with Gold Card which is valid for 3 years, post which the workmen has to reappear for the assessment. If the workman is not able to qualify the assessment, he/she will be given 3 additional attempts to clear in 3 month timeframe failing which he/she will not be allowed to work on high risk jobs.

5. Pre-Employment and Periodic Medical check up

Contractor shall arrange to conduct a pre-employment and periodic medical check-up for its entire workforce by Tata Power medical officer or Tata Power authorized medical officer. The contractor shall be able to produce the certificate prior to the employment. The contractor shall also organize to conduct periodical medical checkup (six monthly) for the following category of employees:

- Drivers (Check for Vision & Hearing)
- Equipment Operators (Check for Vision & Hearing)
- Workforce working at Height (Check for Vision, Hearing, Vertigo & Height Phobia)
- Workforce Handling the hazardous substances (Coal, ash and chemicals)
- Workforce in high decibel area (> 90 Decibel, Check for Hearing)
- Workforce, working in specific areas requiring specific medical attention should conduct the medical test as laid down in the respective Site Safety Management Plan.

6. Safety Performance Evaluation and Penalties

A certain percentage of the bill value will be retained against every running bill as safety performance retention. The amount will be released with the last invoice based on "Safety Performance score" attached in CSM-F-3 of CSM procedure. The amount is based on following table

Contract Value	Retention Amount (%)
Upto 10 Lakhs	2.5
10 – 50 lakhs	2
0.5 to 10 Cr	1.5
>10 Cr	1

- Safety performance Score will be monitored by the Order Manager every month.



NIT No.: TPCODL/P&S/100000082/2021-22

TP CENTRAL ODISHA DISTRIBUTION LIMITED

(A Tata Power & Odisha Govt. joint venture)

2nd Floor, IDCO Tower, Janpath Bhubaneshwar, Odisha 751022

- For the contract value of more than Rs 1 Cr or contract duration more than 12 months, the retention amount shall be released half yearly based on safety performance. For all remaining contracts, the retention amount will be released with the final bill.
- In case of job stoppage due to safety violations/ unsafe observations at the site, no time extension shall be given to the contractor, if such delays are attributable to contractor.
- In case of fatality, limb loss or loss of property, vendor has to pay for liability, legal, statutory and additional mutually agreed settlement charges imposed by the appointed committee. This charge is over and above the retention amount.
- The committee will finalize an amount between 5 -50 lakhs based on factors such as advise by statutory authorities, contract value and impact of accident etc.
- Safety performance bonus 1% (limiting to 50 lakhs) of the invoice value will be considered at the end of the job if the contractual safety performance score is 100%.
- During the progress of the work, concerned Supervisor/Engineer will visit and inspect the work site regularly and evaluate the safety performance of the contractor based on matrix attached herewith.
- Order Manager, divisional chief and SBU head have the authority to terminate the contract in case of three consecutive serious violations.

7. Safety Performance Evaluation - CSM-F-3

S. No.	Lead Indicators	Unit Of measurement	Target	Weightage
1	% of Employee certified in TPSDI/Authorized agency	%	50	10
2	CFSA score (Annexure 6.1)	Average Severity of Violations	1.49	20
3	Monthly inspection completed for Critical Equipments, lifting Tools & Tackles and hand tools used at site	%	80	5
4	Condition of tools, tackles and equipments	%	100	15
	Lag Indicators			
1	Number of Fatalities	No.	0	30
2	Number of Lost work day case (LWDC)	No.	0	10
3	Man-days Lost	No.	0	10

In addition to above evaluation criteria, for specific violations penalty shall be imposed on the contractors under following circumstances:



NIT No.: TPCODL/P&S/100000082/2021-22

TP CENTRAL ODISHA DISTRIBUTION LIMITED
(A Tata Power & Odisha Govt. joint venture)
2nd Floor, IDCO Tower, Janpath Bhubaneshwar, Odisha 751022

Sr No	Description of violation	Severity	Penalty /
1.	Working without Permit	5	5000/-
2.	Untrained (TPSDI) worker on high-risk jobs.	5	5000/-
3.	Unhygienic/Bad condition of PPE	2	250/-
4.	Not following Tata Power Procedure & Standard	4	2000/-
5.	Unsafe Act/Condition of Severity 4	4	2000/-
6.	Unsafe Act/Condition of Severity 5	5	5000/-
7.	No Earthing of Electrical equipment	5	5000/-
8.	Damaged welding cable	5	5000/-
9.	Violation of Positive Isolation Procedure (LOTO Not followed)	5	5000/-
10.	ELCB of more than 30 mA/ELCB not working	5	5000/-
11.	On/Off switch of welding m/c not working	5	5000/-
12.	Electric cable tied with metal wire	5	5000/-
13.	Leakage found DA hose / cylinder	5	5000/-
14.	Use of LPG	5	5000/-
15.	Use of Three-wheeler at the work site.	5	5000/-
16.	Starting the job without Tool Box Talk	5	5000/-
17.	Spatter falling on DA hose / Gas-line/ pathways / Equipment	5	5000/-
18.	No safety latch in crane hook	5	5000/-
19.	Load raised or swung over people or occupied areas of buildings	5	5000/-
20.	Persons standing in swing area of construction equipments.	5	5000/-
21.	Using damaged slings.	5	5000/-
22.	Unstable scaffolding/non standard Scaffolding in use	5	5000/-
23.	Handrails and mid-rails are missing	5	5000/-
24.	Safety Harness not anchored with lifeline/fixed structure	5	5000/-
25.	Fall arrestor not provided/ Not being used.	5	5000/-
26.	Double life line not used for working at height	5	5000/-
27.	No rubber mat in DB room	4	2000/-
28.	Water found accumulated in DB room/near welding machine.	4	2000/-
29.	Inserting electric cables into socket, without using plug.	4	2000/-
30.	Use of damaged electrical cable/two core cables.	4	2000/-
31.	Inflammable material found in D.B Room./ welding areas.	4	2000/-
32.	Loose material falling into excavated pit	4	2000/-
33.	Water logging into excavated pit	4	2000/-
34.	No / inadequate Barricade	4	2000/-



NIT No.: TPCODL/P&S/100000082/2021-22

TP CENTRAL ODISHA DISTRIBUTION LIMITED
(A Tata Power & Odisha Govt. joint venture)
2nd Floor, IDCO Tower, Janpath Bhubaneshwar, Odisha 751022

Sr No	Description of violation	Severity	Penalty /
35.	Undercut / cave-in found on sides of excavated pits	4	2000/-
36.	Grinding wheel/ Coupling/ Piling winch/other rotating parts without guard	4	2000/-
37.	The HMV/Mobile Crane operator does not having a valid HMV driving license.	4	2000/-
38.	The loading area is not leveled properly.	4	2000/-
39.	Ladder not anchored at top	4	2000/-
40.	Opening found in working platform of scaffolding/floor	4	2000/-
41.	Inadequate illumination at the working area.	4	2000/-
42.	Loose material lying on Gantry platform	4	2000/-
43.	Cleaning body with Compressed Air.	3	500/-
44.	Gas Cylinders using without cap.	3	500/-
45.	Gas Cylinders stored without securing	3	500/-
46.	Bringing inside any other chemicals, apart from approved by Safety dept.	3	500/-
47.	Using drum for sitting or accessing height.	3	500/-
48.	Misusing emergency facilities like fire hydrant line/ hose box/ spray system/ eye wash etc.	3	500/-
49.	No provision of Safety net where falling materials or tools may occurs	3	500/-
50.	Taking electrical supply from non designated outlet (other than socket).	3	500/-
51.	Restricted gangways due to unwanted materials.	3	500/-
52.	Not reporting incident.	3	500/-
53.	Entering into restricted area like switch yard/ hazardous storage etc.	3	500/-
54.	Work without supervision	3	500/-
55.	Parking of vehicle without applying wheel choke at right front-front and left rear-rear wheels other than passengers cars.	3	500/-
56.	Vehicle without helper or co-driver.	3	500/-
57.	Not wearing florescent safety jacket at site.	3	500/-
58.	People travelling in load body of vehicle.	3	500/-
59.	Parking of vehicles at non designated area.	3	500/-
60.	Shifting heavy materials without guide ropes.	3	500/-
61.	Using other than 24V lamp inside the confined space/Use of other than 24V lamps.	3	500/-
62.	Angular/ starch loading/ lifting with Crane or hoist.	3	500/-
63.	By passing the limit switch/ Safety Interlock.	3	500/-
64.	Housekeeping activities on road without proper barricade.	3	500/-



NIT No.: TPCODL/P&S/1000000082/2021-22

TP CENTRAL ODISHA DISTRIBUTION LIMITED
 (A Tata Power & Odisha Govt. joint venture)
 2nd Floor, IDCO Tower, Janpath Bhubaneswar, Odisha 751022

Sr No	Description of violation	Severity	Penalty /
65.	Trying to board or alit from running vehicle.	3	500/-
66.	Cylinder Valves of Gas cylinders not closed when not in use.	3	500/-
67.	Flash-back arrester not used.	3	500/-
68.	Trolley wheel found damaged.	3	500/-
69.	Guy ropes of required length on both sides of object are not used during movement with load.	3	500/-
70.	Scotch block/wedge not provide when the vehicle is parked.	3	500/-
71.	Suitable Trolley not provided to hold the cylinders.	3	500/-
72.	Locked First Aid box	3	500/-
73.	Caution boards, danger signs (luminescent /red) along with emergency contact number are not found displayed.	3	500/-
74.	Person found jumping barricading tape	3	500/-
75.	Stacking of pipes, pile casing, drums without chock blocks/wedges	3	500/-
76.	The terrain on which Heavy Equipment/Machinery moves is not reasonably hard.	3	500/-
77.	Without Safety Helmet at working sites	4	250/-
78.	Without Crash Helmet (on bikes)	4	500/-
79.	Without Full body double lanyard Safety Harness (for work at height)	5	5000/-
80.	Without Hand gloves - Material Handling, Welding, Cutting.	4	100/-
81.	Without Safety goggles/ face shield - Welding/Cutting /Grinding	5	5000/-
82.	Handling Chemical without PVC Apron	5	5000/-
83.	Smoking in prohibited area (Closed Go-downs, Storage of flammable material, Storage of Gas cylinders)	5	1000/-
84.	Sleeping at Work Place	3	100/-
85.	Driving beyond speed limit.	3	1000/-
86.	Seat Belt While Driving (for front seat passengers and driver)	3	500/-
87.	Driving without license	4	1000/-
88.	Heavy Commercial vehicles without reverse horn	3	500/-
89.	Non functional Head light/ tail light and side indicators	3	100/-
90.	Using Mobile Phone During Driving	5	5000/-
91.	Poor visibility of registration number/ without registration number	3	100/-
92.	Broken/ without Side view mirror	3	100/-
93.	Over speeding above specified limit	3	500/-
94.	Broken/ Without Pressure gauge on Oxygen/ LPG / Acetylene cylinder.	3	500/-

TP CENTRAL ODISHA DISTRIBUTION LIMITED
 (A Tata Power & Odisha Govt. joint venture)
 2nd Floor, IDCO Tower, Janpath Bhubaneshwar, Odisha 751022

Sr No	Description of violation	Severity	Penalty /
95.	Without Flash back arrestor on Industrial Acetylene & Oxygen cylinders.	5	5000/-
96.	Spillage of hazardous material/chemicals during transportation	4	2000/-
97.	Electrical equipment without Earthing/ ELCB/ Double Insulation Cable.	5	5000/-
98.	Lifting Tools & Tackles used without/ expired Test Certificates.	5	5000/-
99.	Housekeeping repeatedly not maintained		
100.	<ul style="list-style-type: none"> • First Time 	3	Warning
101.	<ul style="list-style-type: none"> • Second Time 	4	1000/-
102.	<ul style="list-style-type: none"> • Third Time 	5	5000/-
103.	Serious Violation Of House Keeping (after 1 st or 2 nd warning to be decided by Project Manager depending on the severity)		Rs.10000/- and above
104.	Repeat Violation of same nature	5	5X Violation



NIT No.: TPCODL/P&S/1000000082/2021-22

TP CENTRAL ODISHA DISTRIBUTION LIMITED
(A Tata Power & Odisha Govt. joint venture)
2nd Floor, IDCO Tower, Janpath Bhubaneshwar, Odisha 751022

ANNEXURE X

TATA CODE OF CONDUCT

The Owner abides by the Tata Code of Conduct in all its dealing with stake holders and the same shall be binding on the Owner and the Contractor for dealings under this Order/ Contract. A copy of the Tata Code of Conduct is available a tour website:

<https://www.tatapower.com/pdf/aboutus/Tata-Code-of-Conduct.pdf>

The Contractor is requested to bring any concerns regarding this to the notice of our Chief Procurement & Stores e-mail ID: pkjain@tatapower.com.

TP CENTRAL ODISHA DISTRIBUTION LIMITED
(A Tata Power & Odisha Govt. joint venture)
2nd Floor, IDCO Tower, Janpath Bhubaneshwar, Odisha 751022

ANNEXURE XI

ENVIRONMENT & SUSTAINABILITY POLICY



CORPORATE ENVIRONMENT POLICY

Tata Power is committed to a clean, safe and healthy environment, and we shall operate our facilities in an environmentally sensitive and responsible manner. Our commitment to environmental protection and stewardship will be achieved by:

- Complying with the requirements and spirit of applicable environmental laws and striving to exceed required levels of compliance wherever feasible
- Ensuring that our employees are trained to acquire the necessary skills to meet environmental standards
- Conserving natural resources by improving efficiency and reducing wastage
- Making business decisions that aim towards sustainable development
- Engaging with stakeholders to create awareness on sustainability

(Praveer Sinha)
CEO & Managing Director

Date: 15th June, 2018

TATA POWER
Lighting up Lives!



TP CENTRAL ODISHA DISTRIBUTION LIMITED
(A Tata Power & Odisha Govt. joint venture)
2nd Floor, IDCO Tower, Janpath Bhubaneshwar, Odisha 751022



CORPORATE SUSTAINABILITY POLICY

At Tata Power, our Sustainability Policy integrates economic progress, social responsibility and environmental concerns with the objective of improving quality of life. We believe in integrating our business values and operations to meet the expectations of our customers, employees, partners, investors, communities and public at large

- We will uphold the values of honesty, partnership and fairness in our relationship with stakeholders
- We shall provide and maintain a clean, healthy and safe working environment for employees, customers, partners and the community
- We will strive to consistently enhance our value proposition to the customers and adhere to our promised standards of service delivery
- We will respect the universal declaration of human rights, International Labour Organization's fundamental conventions on core labour standards and operate as an equal opportunities employer
- We shall encourage and support our partners to adopt responsible business policies, Business Ethics and our Code of Conduct Standards
- We will continue to serve our communities:
 - By implementing sustainable Community Development Programmes including through public/private partnerships in and around our area of operations
 - By constantly protecting ecology, maintaining and renewing bio-diversity and wherever necessary conserving and protecting wild life, particularly endangered species
 - By encouraging our employees to serve communities by volunteering and by sharing their skills and expertise
 - By striving to deploy sustainable technologies and processes in all our operations and use scarce natural resources efficiently in our facilities
 - We will also help communities that are affected by natural calamities or untoward incidence, or that are physically challenged in line with the Tata Group's efforts

The management will commit all the necessary resources required to meet the goals of Corporate Sustainability.



(Praveer Sinha)
CEO & Managing Director

Date: 15th June, 2018

TATA POWER
Lighting up Lives!



TPC^oDL <small>TP CENTRAL ODISHA DISTRIBUTION LIMITED</small>	TATA POWER CENTRAL ODISHA DISTRIBUTION LIMITED, ODISHA		
	TECHNICAL SPECIFICATION		
Document Title	Specification of V Cross Arm for 11KV line WPB,RSJ & PSC pole		
Document No.	ENG-HV-010	Eff. Date: 1.03.2021	
Revision No.	00	Page 1 of 8	
Prepared By Priyanka Dash	Reviewed By Niranjan Khuntia	Approved By Khajan C. Bhardwaj	Issued By Pourush Garg

CONTENTS

1. SCOPE
2. APPLICABLE STANDARDS
3. CLIMATIC CONDITIONS OF THE INSTALLATION
4. GENERAL CONSTRUCTIONS
5. GENERAL TECHNICAL REQUIREMENTS
6. MARKING
7. TESTS
8. TYPE TEST CERTIFICATES
9. PRE-DESPATCH INSPECTION
10. INSPECTION AFTER RECEIPT AT STORES
11. GUARANTEE
12. PACKING
13. TENDER SAMPLE
14. QUALITY CONTROL
15. MINIMUM TESTING FACILITIES
16. MANUFACTURING ACTIVITIES
17. SPARES, ACCESSORIES AND TOOLS
18. DRAWINGS
19. SCHEDULE OF DEVIATIONS

Initiator		HOG (Plant Engineering)	
-----------	--	--------------------------	--

TPCØDL <small>TP CENTRAL ODISHA DISTRIBUTION LIMITED</small>	TATA POWER CENTRAL ODISHA DISTRIBUTION LIMITED, ODISHA		
	TECHNICAL SPECIFICATION		
Document Title	Specification of Specification of V Cross Arm for 11KV line WPB,RSJ,PSC		
Document No.	ENG-HV-010	Eff. Date: 1.03.2021	
Revision No.	00	Page 2 of 8	
Prepared By Priyanka Dash	Reviewed By Niranjan Khuntia	Approved By Khajan C. Bhardwaj	Issued By Pourush Garg

1.0 SCOPE

The scope of this document is to give design & constructional features, inspection, supply and transportation guidelines for V Cross arm used in 11 KV lines.

2.0 APPLICABLE STANDARDS

The equipment covered by this specification shall unless otherwise stated, be designed, manufactured and tested in accordance with latest editions of the following standards/IEC and shall conform to the regulations of local statutory authorities.

- a) IS 2062:2011 - For Hot rolled medium and high tensile structural steel- specification
- b) IS 1852-1985 - For Rolling and cutting tolerances for hot rolled steel products
- c) IS 2629-1985 - For Recommended practice for hot dip galvanized of iron and steel
- d) IS 4759-1996 - For Hot dip zinc coatings on structural steel and other allied products- specification
- e) IS 808-1989 - Dimensions for Hot Rolled Steel Beam, Column, Channel and Angle Sections

3.0 CLIMATIC CONDITIONS OF THE INSTALLATION:

The service conditions shall be as follows:

1. Maximum altitude above sea level 1,000m
2. Maximum ambient air temperature 50°C
3. Maximum daily average ambient air temperature 35°C
4. Minimum ambient air temperature 0°C
5. Maximum relative humidity 95%
6. Average number of thunderstorm days per annum (isokeraunic level) 70
7. Average number of rainy days per annum 120
8. Average annual rainfall 150cm
9. Earthquakes of an intensity in horizontal direction - equivalent to seismic acceleration of 0.3g
10. Earthquakes of an intensity in vertical direction - equivalent to seismic acceleration of 0.15g (g being acceleration due to gravity)
11. Wind velocity: 300 km/hr, 200 km/hr and 160 km/hr.

Environmentally, some of the regions, where the work will take place includes coastal areas, subject to high relative humidity, which can give rise to condensation. Onshore winds will frequently be salt laden. On occasions, the combination of salt and condensation may create pollution conditions for outdoor insulators. Some places are in heavily industrial polluted areas.

Therefore, Outdoor material and equipment shall be designed and protected for use in exposed, heavily polluted, salty, corrosive and humid coastal atmosphere

The design of equipment and accessories shall be suitable to withstand seismic forces corresponding to an acceleration of 0.1 g.

4.0 GENERAL CONSTRUCTION:

The material shall be-

- a) MS channel shall be ISMC 75*40*4.8 (7.14Kg/Mtr)
- b) Hot dip galvanizing to be done after fabrication only.
- c) The design shall be suitable for the climatic condition stated above.
- d) The constructional details shall be as per the attached drawing.
- e) Dimensional tolerance shall be limited to 2% except tolerance on thickness until and unless otherwise specified.
- f) Zinc electroplated/painted material will not be accepted

Initiator		HOG (Plant Engineering)	
-----------	--	--------------------------	--

TPCODL <small>TP CENTRAL ODISHA DISTRIBUTION LIMITED</small>	TATA POWER CENTRAL ODISHA DISTRIBUTION LIMITED, ODISHA		
	TECHNICAL SPECIFICATION		
Document Title	Specification of Specification of V Cross Arm for 11KV line WPB,RSJ,PSC		
Document No.	ENG-HV-010	Eff. Date: 1.03.2021	
Revision No.	00	Page 3 of 8	
Prepared By Priyanka Dash	Reviewed By Niranjan Khuntia	Approved By Khajan C. Bhardwaj	Issued By Pourush Garg

g) Approximate weight shall be 10.64 kg

5.0 MARKING:

The unit shall be appropriately marked as "**PROPERTY OF TPCODL, BHUBANESWAR**" and with the name of the vendor and year of manufacturing at suitable location.

7.0 TESTS

All routine, acceptance & type tests shall be carried out in accordance with the relevant IS/IEC. All routine/acceptance tests shall be witnessed by the purchaser/his authorized representative. All components shall also be type tested as per the relevant standards.

Tests	IS to be referred
Visual test	As a routine test
Dimensional tests	As per the drawing
Tensile strength	IS 2062
Bend test	IS 2062
Impact test	IS 2062
Hot dip galvanizing	IS 4759 : 1996

8.0 TYPE TEST CERTIFICATE

The bidder shall furnish the type test certificates of the V cross Arm for the tests as mentioned above as per the corresponding standards. All the tests shall be conducted at NABL accredited labs as per the relevant standards. Type tests should have been conducted during the period not exceeding 5 years from the date of opening the bid. In the event of any discrepancy in the test reports i.e. any test report not acceptable or any/all type tests (including additional type tests, if any) not carried out, same shall be carried out without any cost implication to TPCODL.

9.0 PRE DISPATCH INSPECTION

Equipment shall be subjected to inspection by a duly authorized representative of TPCODL. Inspection may be made at any stage of manufacture at the discretion of the purchaser and the equipment, if found unsatisfactory as to workmanship or material, the same is liable to rejection. Bidder shall grant free access to the places of manufacture to TPCODL's representatives at all times when the work is in progress. Inspection by TPCODL or its authorized representatives shall not relieve the bidder of his obligation of furnishing equipment in accordance with the specifications. Material shall be dispatched after specific MDCC (Material Dispatch Clearance Certificate) is issued by TPCODL.

Following documents shall be sent along with material.

- a) Test reports
- b) MDCC issued by TPCODL.
- c) Invoice in duplicate
- d) Packing list
- e) Drawings & catalogue
- f) Guarantee / Warrantee card
- g) Delivery Challan
- h) Other Documents (as applicable)

Initiator		HOG (Plant Engineering)	
-----------	--	--------------------------	--

TPCODL <small>TP CENTRAL ODISHA DISTRIBUTION LIMITED</small>	TATA POWER CENTRAL ODISHA DISTRIBUTION LIMITED, ODISHA		
	TECHNICAL SPECIFICATION		
Document Title	Specification of Specification of V Cross Arm for 11KV line WPB,RSJ,PSC		
Document No.	ENG-HV-010	Eff. Date: 1.03.2021	
Revision No.	00	Page 4 of 8	
Prepared By Priyanka Dash	Reviewed By Niranjan Khuntia	Approved By Khajan C. Bhardwaj	Issued By Pourush Garg

10.0 INSPECTION AFTER RECEIPT AT STORES

The material received at TPCODL, Bhubaneswar, Odisha store will be inspected for acceptance and shall be liable for rejection, if found different from the reports of the pre-dispatch inspection and one copy of the report shall be sent to Engineering and contracts department.

11.0 GUARANTEE

Bidder shall stand guarantee towards design, materials, workmanship & quality of process / manufacturing of items under this contract for due and intended performance of the same, as an integrated product delivered under this contract. In the event any defect is found by the Company up to a period of at least 12 months from the date of commissioning or 24 months from the date of last supplies made under the contract whichever is later. In the event any defect is found by the Company up to a period of 12 months from the date of commissioning or 24 months from the date of last supplies made under the contract, whichever is earlier, supplier shall be liable to undertake to replace/rectify such defects at his own costs.

12.0 PACKING

Bidder shall ensure that all the equipment covered under this specification shall be prepared for rail/road transport in a manner so as to protect the equipment from damage in transit.

13.0 TENDER SAMPLE

Not required.

14.0 QUALITY CONTROL

The bidder shall submit with the offer Quality assurance plan indicating the various stages of inspection, the tests and checks which will be carried out on the material of construction, components during manufacture and bought out items and fully assembled component and equipment after finishing. As part of the plan, a schedule for stage and final inspection within the parameters of the delivery schedule shall be furnished. TPCODL's engineer or its nominated representative shall have free access to the manufacturer's/sub-supplier's works to carry out inspections.

15.0 MINIMUM TESTING FACILITIES

Bidder shall have adequate in house testing facilities for carrying out all routine tests & acceptance tests as per relevant International / Indian standards

16.0 MANUFACTURING ACTIVITIES

The successful bidder will have to submit the bar chart for various manufacturing activities clearly elaborating each stage, with quantity. This bar chart should be in line with the Quality assurance plan submitted with the offer. This bar chart will have to be submitted within 15 days from the release of the order.

17.0 SPARES, ACCESSORIES AND TOOLS

Bidder shall provide a list of recommended spares with quantity and unit prices for 3 years of operation after commissioning. The bidder shall provide a list of complete set of accessories and tools required for erection & maintenance along with the installation procedure.

Initiator		HOG (Plant Engineering)	
-----------	--	--------------------------	--

TPCØDL <small>TP CENTRAL ODISHA DISTRIBUTION LIMITED</small>	TATA POWER CENTRAL ODISHA DISTRIBUTION LIMITED, ODISHA		
	TECHNICAL SPECIFICATION		
Document Title	Specification of Specification of V Cross Arm for 11KV line WPB,RSJ,PSC		
Document No.	ENG-HV-010	Eff. Date: 1.03.2021	
Revision No.	00	Page 5 of 8	
Prepared By Priyanka Dash	Reviewed By Niranjan Khuntia	Approved By Khajan C. Bhardwaj	Issued By Pourush Garg

18.0 DRAWINGS

Following drawings & documents shall be prepared based on Purchaser's specifications and statutory requirements with complete BOM and shall be submitted with the bid:

- a) General description of the equipment and all components including brochures
- b) General arrangement drawings
- c) Type Test Certificates.
- d) Experience List
- e) Manufacturing schedule and test schedule.

After the contract, four (4) copies of the drawings, drawn to scale, describing the equipment in detail shall be forwarded for approval and shall subsequently provide four (4) complete sets of final drawings, one of which shall be auto positive suitable for reproduction, before the dispatch of the equipment. Soft copy (Compact Disk CD) of all the drawing, test certificates shall be submitted after the final approval of the same to the purchaser.

Following Drawings/Documents shall be submitted after the award of the contract:
 Drawings/documents to be submitted after the award of the contract:

S.No	Description	For Approval	For Review Information	Final Submission
1	Technical Parameters	√		√
2	General Arrangement drawings	√		√
3	Manual/Catalogues/drawings		√	
4	Installation Instructions (if any)		√	√
5	QA &QC Plan	√	√	√
6	Routine, Acceptance & Type Test Certificates	√	√	√

All the documents & drawings shall be in English language.

Initiator		HOG (Plant Engineering)	
-----------	--	--------------------------	--

TPCØDL TP CENTRAL ODISHA DISTRIBUTION LIMITED	TATA POWER CENTRAL ODISHA DISTRIBUTION LIMITED, ODISHA		
	TECHNICAL SPECIFICATION		
Document Title	Specification of Specification of V Cross Arm for 11KV line WPB,RSJ,PSC		
Document No.	ENG-HV-010	Eff. Date: 1.03.2021	
Revision No.	00	Page 6 of 8	
Prepared By Priyanka Dash	Reviewed By Niranjana Khuntia	Approved By Khajan C. Bhardwaj	Issued By Pourush Garg

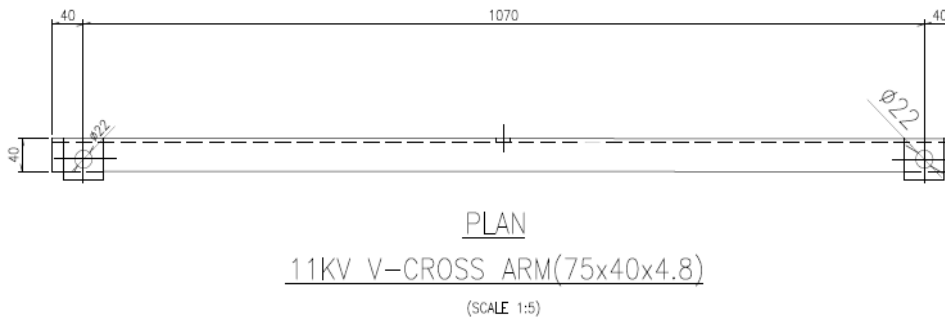
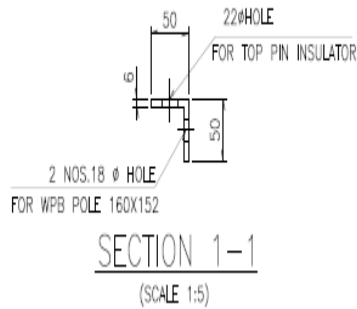
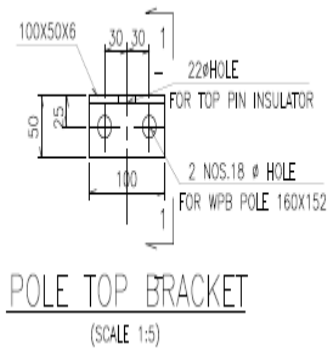
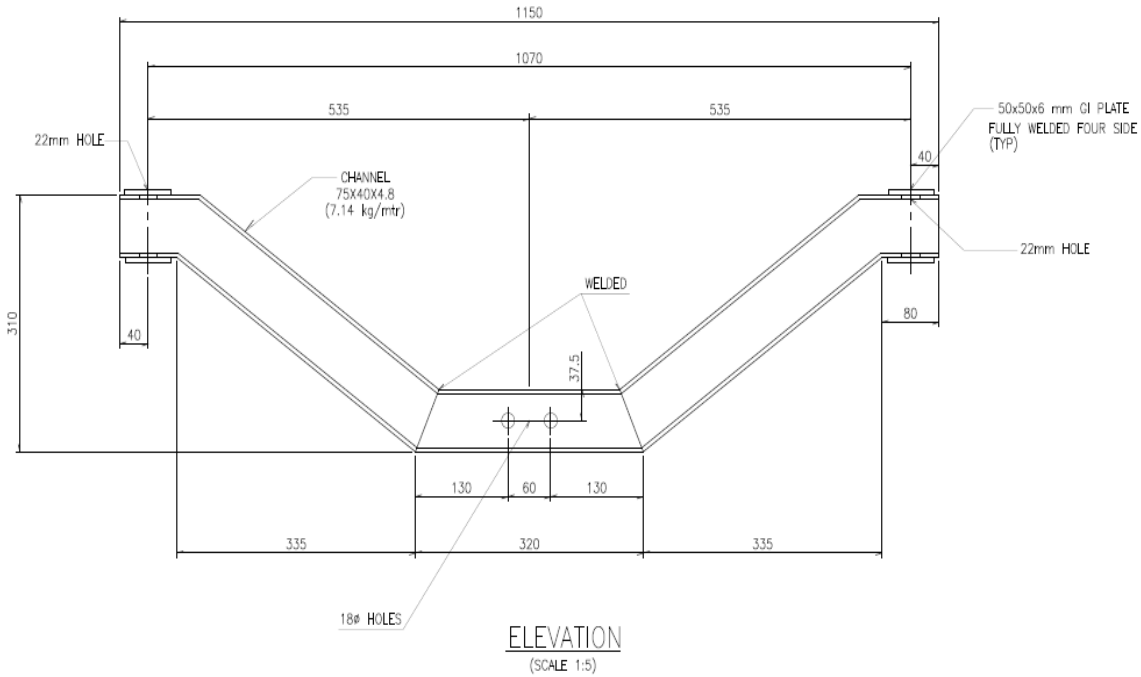

Initiator		HOG (Plant Engineering)	
-----------	--	--------------------------	--

TPC_{ODL} TP CENTRAL ODISHA DISTRIBUTION LIMITED	TATA POWER CENTRAL ODISHA DISTRIBUTION LIMITED, ODISHA		
	TECHNICAL SPECIFICATION		
Document Title	Specification of Specification of V Cross Arm for 11KV line WPB,RSJ,PSC		
Document No.	ENG-HV-010	Eff. Date: 1.03.2021	
Revision No.	00	Page 7 of 8	
Prepared By Priyanka Dash	Reviewed By Niranjana Khuntia	Approved By Khajan C. Bhardwaj	Issued By Pourush Garg

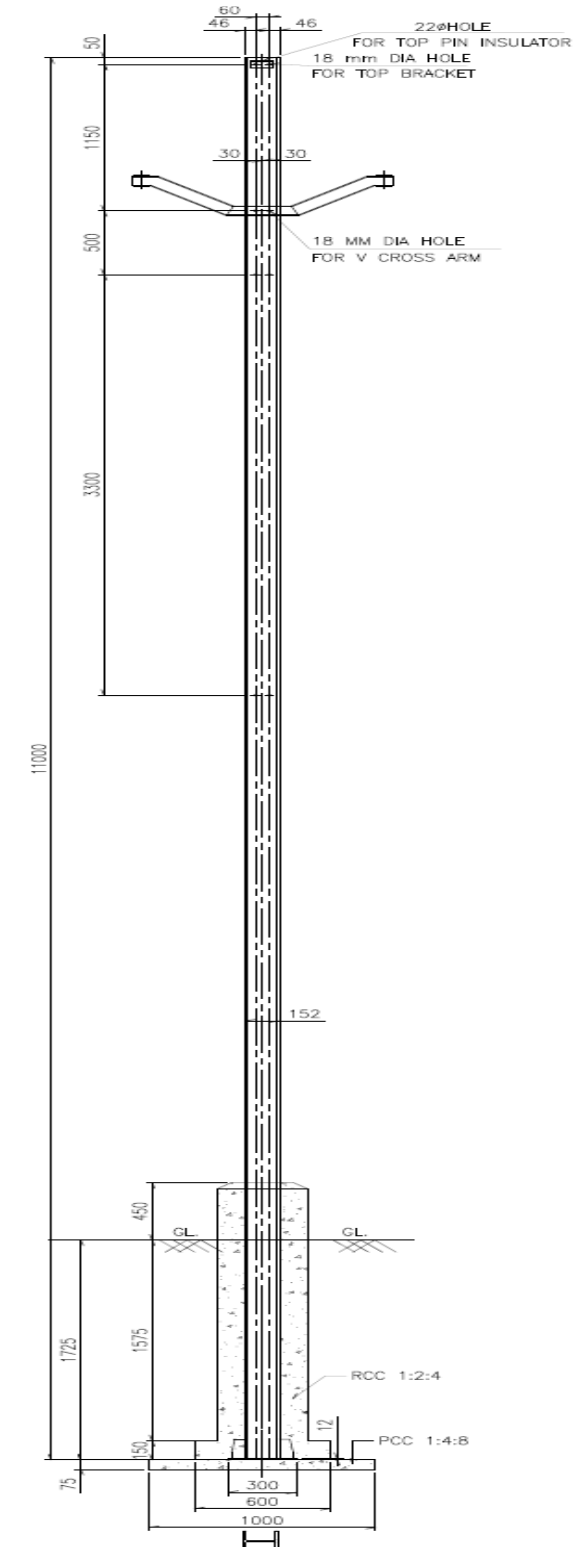

11KV LINE WITH WPB 160X152
SINGLE POLE STRUCTURE

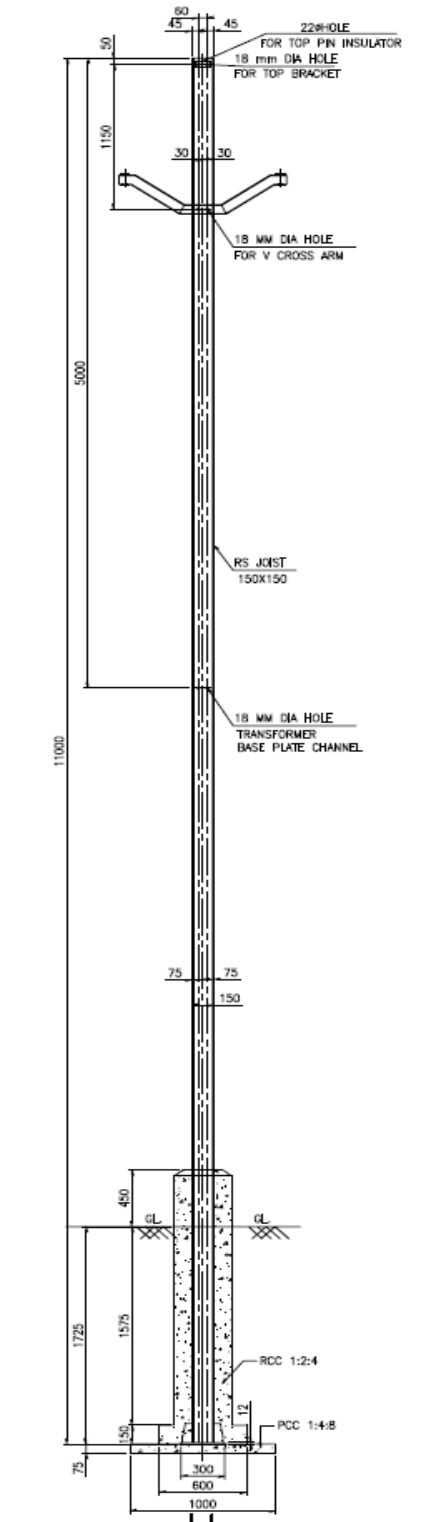

11KV LINE WITH RS JOIST 150X150
SINGLE POLE STRUCTURE

Initiator		HOG (Plant Engineering)	
-----------	--	--------------------------	--

TPCØDL TP CENTRAL ODISHA DISTRIBUTION LIMITED	TATA POWER CENTRAL ODISHA DISTRIBUTION LIMITED, ODISHA		
	TECHNICAL SPECIFICATION		
Document Title	Specification of Specification of V Cross Arm for 11KV line WPB,RSJ,PSC		
Document No.	ENG-HV-010	Eff. Date: 1.03.2021	
Revision No.	00	Page 8 of 8	
Prepared By Priyanka Dash	Reviewed By Niranjana Khuntia	Approved By Khajan C. Bhardwaj	Issued By Pourush Garg

11KV V Cross Arm to be used in 9Mtr PSC Pole 300Kg

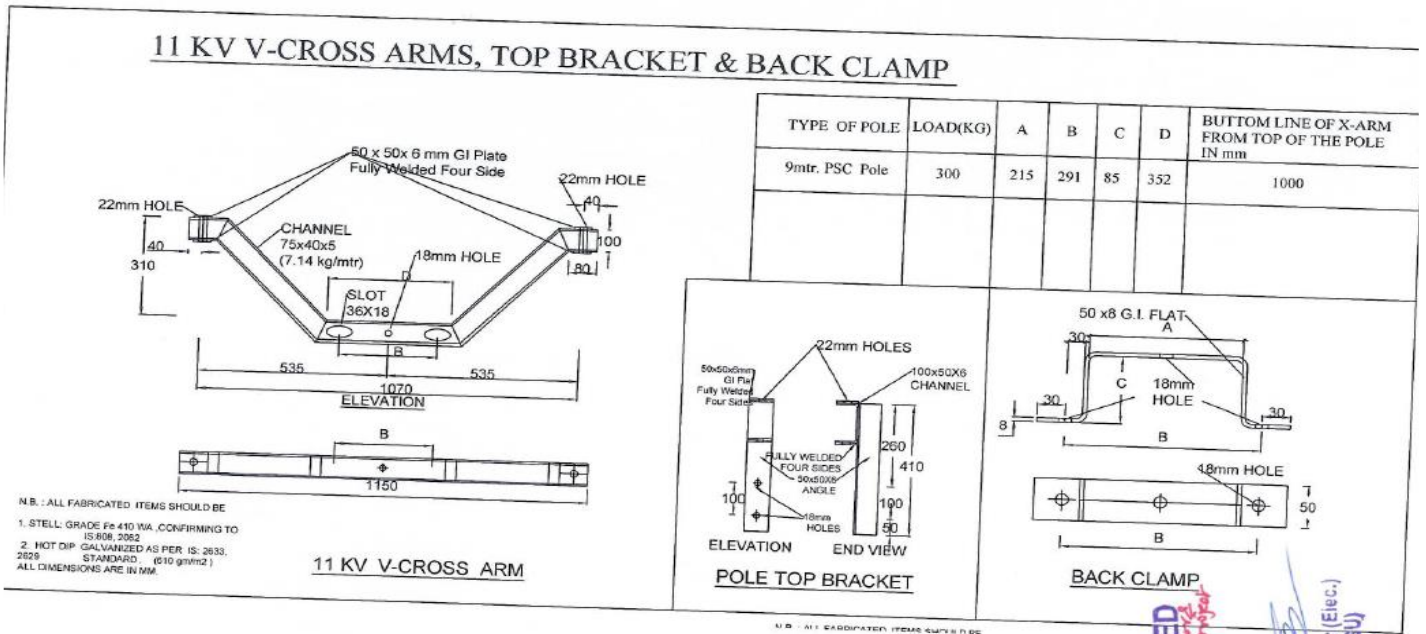

APPROVED

Sr. General Manager (Elec.)
Technical, CESU

19. SCHEDULE OF DEVIATIONS

SCHEDULE OF DEVIATIONS

(TO BE ENCLOSED WITH TECHNICAL BID)

All deviations from this specification shall be set out by the Bidders, clause by Clause in this schedule. Unless specifically mentioned in this Schedule, the tender shall be deemed to confirm the purchaser's specifications:

S.No	Clause No.	Details of deviation with justifications
------	------------	--

Initiator		HOG (Plant Engineering)	
-----------	--	--------------------------	--

TPC_{ODL} <small>TP CENTRAL ODISHA DISTRIBUTION LIMITED</small>	TATA POWER CENTRAL ODISHA DISTRIBUTION LIMITED, ODISHA		
	TECHNICAL SPECIFICATION		
Document Title	Specification of Specification of V Cross Arm for 11KV line WPB,RSJ,PSC		
Document No.	ENG-HV-010	Eff. Date: 1.03.2021	
Revision No.	00	Page 9 of 8	
Prepared By Priyanka Dash	Reviewed By Niranjan Khuntia	Approved By Khajan C. Bhardwaj	Issued By Pourush Garg

--	--	--

We confirm that there are no deviations apart from those detailed above.

Seal of the Company:

Signature
Designation

Initiator		HOG (Plant Engineering)	
-----------	--	--------------------------	--

 TP CODL TP CENTRAL ODISHA DISTRIBUTION LIMITED	TATA POWER CENTRAL ODISHA DISTRIBUTION LIMITED, ODISHA		
	TECHNICAL SPECIFICATION		
Document Title	Standard Technical Particulars for 33KV V-Cross Arm, Back Clamp & F Clamp(Pole Top Bracket) for 160x160 WPB / 150X150 RSJ		
Document No.			Eff. Date: 1.4.2021
Revision No.	ENG-HV-029		Page 1 of 7
Prepared By Suchismita Nayak	Reviewed By Niranjan Khuntia	Approved By Khajan C. Bhardwaj	Issued By Pourush Garg

CONTENTS

1. SCOPE
2. APPLICABLE STANDARDS
3. CLIMATIC CONDITIONS OF THE INSTALLATION
4. GENERAL TECHNICAL REQUIREMENTS
5. GENERAL CONSTRUCTIONS
6. MARKING
7. TESTS
8. TYPE TEST CERTIFICATES
9. PRE-DISPATCH INSPECTION
10. INSPECTION AFTER RECEIPT AT STORES
11. GUARANTEE
12. PACKING
13. TENDER SAMPLE
14. QUALITY CONTROL
15. MINIMUM TESTING FACILITIES
16. MANUFACTURING ACTIVITIES
17. SPARES, ACCESSORIES AND TOOLS
18. DRAWINGS AND DOCUMENTS
19. GUARANTEED TECHNICAL PARTICULARS
20. SCHEDULE OF DEVIATIONS

Prepared By Suchismita Nayak	Reviewed By Niranjan Khuntia	Approved By Khajan C. Bhardwaj	Issued By Pourush Garg

 TP CODL TP CENTRAL ODISHA DISTRIBUTION LIMITED	TATA POWER CENTRAL ODISHA DISTRIBUTION LIMITED, ODISHA		
	TECHNICAL SPECIFICATION		
Document Title	Standard Technical Particulars for 33KV V-Cross Arm, Back Clamp & F Clamp(Pole Top Bracket)		
Document No.	ENG-HV-029	Eff. Date: 1.03.2021	
Revision No.	00	Page 2 of 7	
Prepared By Suchismita Nayak	Reviewed By Niranjan Khuntia	Approved By Khajan C. Bhardwaj	Issued By Pourush Garg

1.0 SCOPE

The scope of this document is to give design & constructional features, inspection, supply and transportation guidelines for V Cross arm used in 33 KV lines

2.0 APPLICABLE STANDARDS

The equipment covered by this specification shall unless otherwise stated, be designed, manufactured and tested in accordance with latest editions of the following standards/IEC and shall conform to the regulations of local statutory authorities.

- a) IS 2062:2011 - For Hot rolled medium and high tensile structural steel- specification
- b) IS 1852-1985 - For Rolling and cutting tolerances for hot rolled steel products
- c) IS 2629-1985 - For Recommended practice for hot dip galvanized of iron and steel
- d) IS 4759-1996 - For Hot dip zinc coatings on structural steel and other allied products- specification
- e) IS 808-1989 - Dimensions for Hot Rolled Steel Beam, Column, Channel and Angle Sections

3.0 CLIMATIC CONDITIONS OF THE INSTALLATION

- a) Maximum altitude above sea level 100m
- b) Max. Ambient Temperature: 50 deg. C
- c) Max. Daily average ambient temp: 35 deg. C
- d) Min. Ambient Temperature: 0 deg. C
- e) Maximum Relative Humidity: 95%
- f) Average No. of thunderstorm days per annum:70
- g) Average Annual Rainfall: 1500 mm
- h) Average No. of rainy days per annum: 120
- i) Earthquakes of an intensity in horizontal direction – equivalent to seismic acceleration of 0.3g.
- j) Earthquakes of an intensity in vertical direction – equivalent to seismic acceleration of 0.15g
- k) Wind velocity: 300/hr, 200 km/hr and 160km/hr

Environmentally, some of the regions, where the work will take place includes coastal regions, subject to high relative humidity, which can give rise to condensation. On shore winds will frequently be salt laden. On occasions the combination of salt and condensation may create pollution conditions for outdoor insulators. Some places are in heavily industrial polluted areas. Therefore, Outdoor material and equipment shall be designed and protected for use in exposed, heavily polluted, salty corrosive and humid coastal atmosphere. The design of equipment and accessories shall be suitable to withstand seismic forces corresponding to an acceleration of 0.1g.

4.0 GENERAL TECHNICAL REQUIREMENTS

Prepared By Suchismita Nayak	Reviewed By Niranjan Khuntia	Approved By Khajan C. Bhardwaj	Issued By Pourush Garg

 TP CODL TP CENTRAL ODISHA DISTRIBUTION LIMITED	TATA POWER CENTRAL ODISHA DISTRIBUTION LIMITED, ODISHA		
	TECHNICAL SPECIFICATION		
Document Title	Standard Technical Particulars for 33KV V-Cross Arm, Back Clamp & F Clamp(Pole Top Bracket)		
Document No.	ENG-HV-029	Eff. Date: 1.03.2021	
Revision No.	00	Page 3 of 7	
Prepared By Suchismita Nayak	Reviewed By Niranjan Khuntia	Approved By Khajan C. Bhardwaj	Issued By Pourush Garg

5.0 GENERAL CONSTRUCTIONS

The material shall be-

- a) V Cross-arms shall be made out M S Channel 100 x 50 x 6 mm, along with dimensions 100 x 50 x 6 mm at Pole top bracket and 65 x 65 x 6 mm plate welded at both ends, for 33KV, suitable for WPB 13mt, to be used in 33KV. (for details refer attached drawing)
- b) The cross arm shall be hot dipped galvanized generally conforming to IS –2633/72.
- c) The V Cross-arm should not be welded/ jointed at any place except as specified.
- d) The clamps for the V Cross-arm shall be of G.I. & shall be hot dipped galvanized generally conforming to IS – 2633/72.
- e) The clamps shall be designed to fit for the specified rail.
- f) Hot dip galvanizing to be done after fabrication only.
- g) The design shall be suitable for the climatic condition stated above.
- h) The constructional details shall be as per the attached drawing.
- i) Dimensional tolerance shall be limited to 2% except tolerance on thickness until and unless otherwise specified.
- j) Zinc electroplated/painted material will not be accepted
- k) Approximate weight shall be 22kg

6.0 MARKING

The unit shall be appropriately marked as "**PROPERTY OF TPCODL, BHUBANESWAR**" and with the name of the vendor and year of manufacturing at suitable location.

7.0 TESTS

All routine, acceptance & type tests shall be carried out in accordance with the relevant IS/IEC. All routine/acceptance tests shall be witnessed by the purchaser/his authorized representative. All components shall also be type tested as per the relevant standards.

Tests	IS to be referred
Visual test	As a routine test
Dimensional tests	As per the drawing
Tensile strength	IS 2062
Bend test	IS 2062
Impact test	IS 2062
Hot dip galvanizing	IS 4759 : 1996

8.0 TYPE TEST CERTIFICATES

Prepared By Suchismita Nayak	Reviewed By Niranjan Khuntia	Approved By Khajan C. Bhardwaj	Issued By Pourush Garg

 TP CODL TP CENTRAL ODISHA DISTRIBUTION LIMITED	TATA POWER CENTRAL ODISHA DISTRIBUTION LIMITED, ODISHA		
	TECHNICAL SPECIFICATION		
Document Title	Standard Technical Particulars for 33KV V-Cross Arm, Back Clamp & F Clamp(Pole Top Bracket)		
Document No.	ENG-HV-029	Eff. Date: 1.03.2021	
Revision No.	00	Page 4 of 7	
Prepared By Suchismita Nayak	Reviewed By Niranjan Khuntia	Approved By Khajan C. Bhardwaj	Issued By Pourush Garg

The bidder shall furnish the type test certificates of the V Cross Arm for the tests as mentioned above as per the corresponding standards. All the tests shall be conducted at NABL accredited labs as per the relevant standards. Type tests should have been conducted during the period not exceeding 5 years from the date of opening the bid. In the event of any discrepancy in the test reports i.e. any test report not acceptable or any/all type tests (including additional type tests, if any) not carried out, same shall be carried out without any cost implication to TPCODL.

9.0 PRE-DISPATCH INSPECTION

Equipment shall be subjected to inspection by a duly authorized representative of TPCODL. Inspection may be made at any stage of manufacture at the discretion of the purchaser and the equipment, if found unsatisfactory as to workmanship or material, the same is liable to rejection. Bidder shall grant free access to the places of manufacture to TPCODL's representatives at all times when the work is in progress. Inspection by TPCODL or its authorized representatives shall not relieve the bidder of his obligation of furnishing equipment in accordance with the specifications. Material shall be dispatched after specific MDCC (Material Dispatch Clearance Certificate) is issued by TPCODL.

Following documents shall be sent along with material.

- a) Test reports
- b) MDCC issued by TPCODL.
- c) Invoice in duplicate
- d) Packing list
- e) Drawings & catalogue
- f) Guarantee / Warrantee card
- g) Delivery Challan
- h) Other Documents (as applicable)

10.0 INSPECTION AFTER RECEIPT AT STORES

The material received at TPCODL, Bhubaneswar, Odisha store will be inspected for acceptance and shall be liable for rejection, if found different from the reports of the pre-dispatch inspection and one copy of the report shall be sent to Engineering and contracts department.

11.0 GUARANTEE

Bidder shall stand guarantee towards design, materials, workmanship & quality of process / manufacturing of items under this contract for due and intended performance of the same, as an integrated product delivered under this contract. In the event any defect is found by the Company up to a period of at least 12 months from the date of commissioning or 24 months from the date of last supplies made under the contract whichever is later. In the event any defect is found by the Company up to a period of 12 months from the date of commissioning or 24 months from the date of last supplies made under the contract, whichever is earlier, supplier shall be liable to undertake to replace/rectify such defects at his own costs.

Prepared By Suchismita Nayak	Reviewed By Niranjan Khuntia	Approved By Khajan C. Bhardwaj	Issued By Pourush Garg

 TP CODL TP CENTRAL ODISHA DISTRIBUTION LIMITED	TATA POWER CENTRAL ODISHA DISTRIBUTION LIMITED, ODISHA		
	TECHNICAL SPECIFICATION		
Document Title	Standard Technical Particulars for 33KV V-Cross Arm, Back Clamp & F Clamp(Pole Top Bracket)		
Document No.	ENG-HV-029	Eff. Date: 1.03.2021	
Revision No.	00	Page 5 of 7	
Prepared By Suchismita Nayak	Reviewed By Niranjan Khuntia	Approved By Khajan C. Bhardwaj	Issued By Pourush Garg

12.0 PACKING

Bidder shall ensure that all the equipment covered under this specification shall be prepared for rail/road transport in a manner so as to protect the equipment from damage in transit.

13.0 TENDER SAMPLE

Not required.

14.0 QUALITY CONTROL

The bidder shall submit with the offer Quality assurance plan indicating the various stages of inspection, the tests and checks which will be carried out on the material of construction, components during manufacture and bought out items and fully assembled component and equipment after finishing. As part of the plan, a schedule for stage and final inspection within the parameters of the delivery schedule shall be furnished. TPCODL's engineer or its nominated representative shall have free access to the manufacturer's/sub-supplier's works to carry out inspections.

15.0 MINIMUM TESTING FACILITIES

Bidder shall have adequate in house testing facilities for carrying out all routine tests & acceptance tests as per relevant International / Indian standards

16.0 MANUFACTURING ACTIVITIES

The successful bidder will have to submit the bar chart for various manufacturing activities clearly elaborating each stage, with quantity. This bar chart should be in line with the Quality assurance plan submitted with the offer. This bar chart will have to be submitted within 15 days from the release of the order.

17.0 SPARES, ACCESSORIES AND TOOLS

Bidder shall provide a list of recommended spares with quantity and unit prices for 3 years of operation after commissioning. The bidder shall provide a list of complete set of accessories and tools required for erection & maintenance along with the installation procedure.

18.0 DRAWINGS AND DOCUMENTS

Following drawings & documents shall be prepared based on Purchaser's specifications and statutory requirements with complete BOM and shall be submitted with the bid:

Sl. No.	Description	For Approval	For Review	Final Submission
1	Technical Parameters	✓		✓
2	GA Drawing	✓		✓
3	Installation Instruction			✓
4	Manuals, Catalogues & Drawings		✓	✓

Prepared By Suchismita Nayak	Reviewed By Niranjan Khuntia	Approved By Khajan C. Bhardwaj	Issued By Pourush Garg

 TP CODL TP CENTRAL ODISHA DISTRIBUTION LIMITED	TATA POWER CENTRAL ODISHA DISTRIBUTION LIMITED, ODISHA		
	TECHNICAL SPECIFICATION		
Document Title	Standard Technical Particulars for 33KV V-Cross Arm, Back Clamp & F Clamp(Pole Top Bracket)		
Document No.	ENG-HV-029	Eff. Date: 1.03.2021	
Revision No.	00	Page 6 of 7	
Prepared By Suchismita Nayak	Reviewed By Niranjan Khuntia	Approved By Khajan C. Bhardwaj	Issued By Pourush Garg

5	Dimension drawing		✓	✓
6	QA & QC Plan	✓	✓	✓
7	Routine, Acceptance & Type Test Certificates	✓	✓	✓

- a) General description of the equipment and all components including brochures
- b) General arrangement drawings
- c) Type Test Certificates.
- d) Experience List
- e) Manufacturing schedule and test schedule.

After the contract, four (4) copies of the drawings, drawn to scale, describing the equipment in detail shall be forwarded for approval and shall subsequently provide four (4) complete sets of final drawings, one of which shall be auto positive suitable for reproduction, before the dispatch of the equipment. Soft copy (Compact Disk CD) of all the drawing, test certificates shall be submitted after the final approval of the same to the purchaser.

Following Drawings/Documents shall be submitted after the award of the contract:
Drawings/documents to be submitted after the award of the contract:

19.0 GUARANTEED TECHNICAL PARTICULARS

Sl.no.	Particulars	Bidder's Offer
1	Type of cross arm	
2	Grade of steel	
3	Steel standard	
4	Fabrication standard	
5	Dimensions	
6	Steel section utilized	
7	Steel tensile strength	
8	Working load	
9	Details of Galvanizing methods utilized and Standard/ Specification	
10	Weight of Cross Arm	
11	Whether Drawing has been submitted with the Bid	

Prepared By Suchismita Nayak	Reviewed By Niranjan Khuntia	Approved By Khajan C. Bhardwaj	Issued By Pourush Garg

 TP CODL TP CENTRAL ODISHA DISTRIBUTION LIMITED	TATA POWER CENTRAL ODISHA DISTRIBUTION LIMITED, ODISHA		
	TECHNICAL SPECIFICATION		
Document Title	Standard Technical Particulars for 33KV V-Cross Arm, Back Clamp & F Clamp(Pole Top Bracket)		
Document No.	ENG-HV-029	Eff. Date: 1.03.2021	
Revision No.	00	Page 7 of 7	
Prepared By Suchismita Nayak	Reviewed By Niranjan Khuntia	Approved By Khajan C. Bhardwaj	Issued By Pourush Garg

20.0 SCHEDULE OF DEVIATIONS

All deviations from this specification shall be set out by the bidder, clause by clause in the below mentioned tabular format. Unless specifically mentioned in this schedule, the tender shall be deemed to confirm TPDDL's Specification.

Sl. No.	Clause No.	Details of deviation with justifications

We confirm that there are no deviations apart from those detailed above.

Seal of the Company
Signature
Designation

Prepared By Suchismita Nayak	Reviewed By Niranjan Khuntia	Approved By Khajan C. Bhardwaj	Issued By Pourush Garg

	TATA POWER CENTRAL ODISHA DISTRIBUTION LIMITED, ODISHA		
	TECHNICAL SPECIFICATION		
Document Title	Standard Technical Particulars for 33KV V-Cross Arm, Back Clamp & F Clamp(Pole Top Bracket)		
Document No.	ENG-HV-029	Eff. Date: 1.03.2021	
Revision No.	00	Page 8 of 7	
Prepared By Suchismita Nayak	Reviewed By Niranjan Khuntia	Approved By Khajan C. Bhardwaj	Issued By Pourush Garg

ANNEXURE-1

DRAWING OF V CROSS ARM WITH DETAILED DIMENSIONS

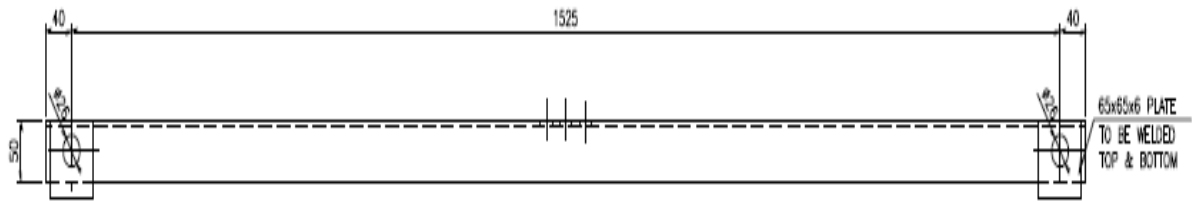

PLAN
V-CROSS ARM(100x50x5)

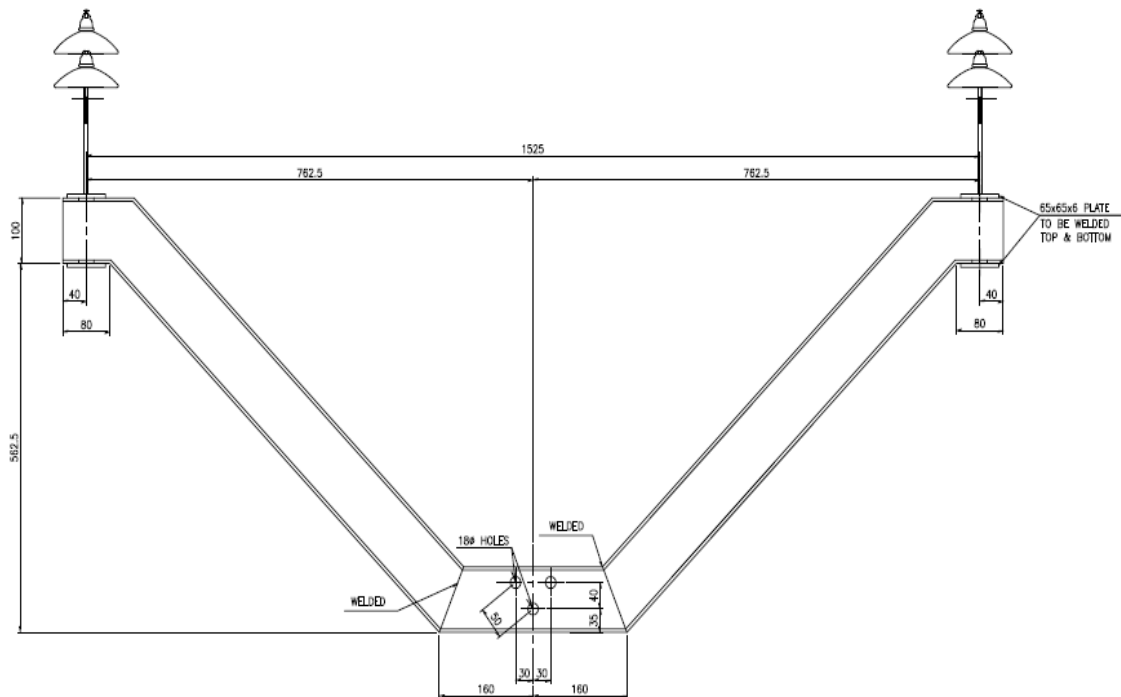

ELEVATION

Prepared By Suchismita Nayak	Reviewed By Niranjan Khuntia	Approved By Khajan C. Bhardwaj	Issued By Pourush Garg
---	---	---	---

TECHNICAL SPECIFICATION

Document Title	Standard Technical Particulars for 33KV V-Cross Arm, Back Clamp & F Clamp(Pole Top Bracket)		
Document No.	ENG-HV-029	Eff. Date: 1.03.2021	
Revision No.	00	Page 9 of 7	
Prepared By Suchismita Nayak	Reviewed By Niranjan Khuntia	Approved By Khajan C. Bhardwaj	Issued By Pourush Garg

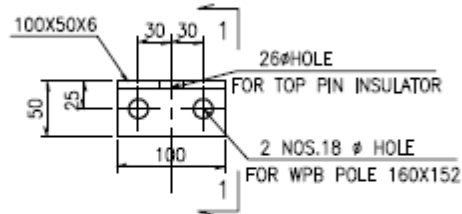

POLE TOP BRACKET
(SCALE 1:5)

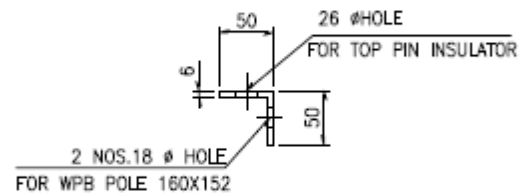

SECTION 1-1
(SCALE 1:5)

Prepared By Suchismita Nayak	Reviewed By Niranjan Khuntia	Approved By Khajan C. Bhardwaj	Issued By Pourush Garg
--	--	--	----------------------------------

 TP CODL TP CENTRAL ODISHA DISTRIBUTION LIMITED	TATA POWER CENTRAL ODISHA DISTRIBUTION LIMITED, ODISHA		
	TECHNICAL SPECIFICATION		
Document Title	Standard Technical Particulars for 33KV V-Cross Arm, Back Clamp & F Clamp(Pole Top Bracket) for 160x160 WPB / 150X150 RSJ		
Document No.			Eff. Date: 1.4.2021
Revision No.	ENG-HV-029		Page 1 of 7
Prepared By Suchismita Nayak	Reviewed By Niranjan Khuntia	Approved By Khajan C. Bhardwaj	Issued By Pourush Garg

CONTENTS

1. SCOPE
2. APPLICABLE STANDARDS
3. CLIMATIC CONDITIONS OF THE INSTALLATION
4. GENERAL TECHNICAL REQUIREMENTS
5. GENERAL CONSTRUCTIONS
6. MARKING
7. TESTS
8. TYPE TEST CERTIFICATES
9. PRE-DISPATCH INSPECTION
10. INSPECTION AFTER RECEIPT AT STORES
11. GUARANTEE
12. PACKING
13. TENDER SAMPLE
14. QUALITY CONTROL
15. MINIMUM TESTING FACILITIES
16. MANUFACTURING ACTIVITIES
17. SPARES, ACCESSORIES AND TOOLS
18. DRAWINGS AND DOCUMENTS
19. GUARANTEED TECHNICAL PARTICULARS
20. SCHEDULE OF DEVIATIONS

Prepared By Suchismita Nayak	Reviewed By Niranjan Khuntia	Approved By Khajan C. Bhardwaj	Issued By Pourush Garg

 TP CODL TP CENTRAL ODISHA DISTRIBUTION LIMITED	TATA POWER CENTRAL ODISHA DISTRIBUTION LIMITED, ODISHA		
	TECHNICAL SPECIFICATION		
Document Title	Standard Technical Particulars for 33KV V-Cross Arm, Back Clamp & F Clamp(Pole Top Bracket)		
Document No.	ENG-HV-029	Eff. Date: 1.03.2021	
Revision No.	00	Page 2 of 7	
Prepared By Suchismita Nayak	Reviewed By Niranjan Khuntia	Approved By Khajan C. Bhardwaj	Issued By Pourush Garg

1.0 SCOPE

The scope of this document is to give design & constructional features, inspection, supply and transportation guidelines for V Cross arm used in 33 KV lines

2.0 APPLICABLE STANDARDS

The equipment covered by this specification shall unless otherwise stated, be designed, manufactured and tested in accordance with latest editions of the following standards/IEC and shall conform to the regulations of local statutory authorities.

- a) IS 2062:2011 - For Hot rolled medium and high tensile structural steel- specification
- b) IS 1852-1985 - For Rolling and cutting tolerances for hot rolled steel products
- c) IS 2629-1985 - For Recommended practice for hot dip galvanized of iron and steel
- d) IS 4759-1996 - For Hot dip zinc coatings on structural steel and other allied products- specification
- e) IS 808-1989 - Dimensions for Hot Rolled Steel Beam, Column, Channel and Angle Sections

3.0 CLIMATIC CONDITIONS OF THE INSTALLATION

- a) Maximum altitude above sea level 100m
- b) Max. Ambient Temperature: 50 deg. C
- c) Max. Daily average ambient temp: 35 deg. C
- d) Min. Ambient Temperature: 0 deg. C
- e) Maximum Relative Humidity: 95%
- f) Average No. of thunderstorm days per annum:70
- g) Average Annual Rainfall: 1500 mm
- h) Average No. of rainy days per annum: 120
- i) Earthquakes of an intensity in horizontal direction – equivalent to seismic acceleration of 0.3g.
- j) Earthquakes of an intensity in vertical direction – equivalent to seismic acceleration of 0.15g
- k) Wind velocity: 300/hr, 200 km/hr and 160km/hr

Environmentally, some of the regions, where the work will take place includes coastal regions, subject to high relative humidity, which can give rise to condensation. On shore winds will frequently be salt laden. On occasions the combination of salt and condensation may create pollution conditions for outdoor insulators. Some places are in heavily industrial polluted areas. Therefore, Outdoor material and equipment shall be designed and protected for use in exposed, heavily polluted, salty corrosive and humid coastal atmosphere. The design of equipment and accessories shall be suitable to withstand seismic forces corresponding to an acceleration of 0.1g.

4.0 GENERAL TECHNICAL REQUIREMENTS

Prepared By Suchismita Nayak	Reviewed By Niranjan Khuntia	Approved By Khajan C. Bhardwaj	Issued By Pourush Garg

 TP CODL TP CENTRAL ODISHA DISTRIBUTION LIMITED	TATA POWER CENTRAL ODISHA DISTRIBUTION LIMITED, ODISHA		
	TECHNICAL SPECIFICATION		
Document Title	Standard Technical Particulars for 33KV V-Cross Arm, Back Clamp & F Clamp(Pole Top Bracket)		
Document No.	ENG-HV-029	Eff. Date: 1.03.2021	
Revision No.	00	Page 3 of 7	
Prepared By Suchismita Nayak	Reviewed By Niranjan Khuntia	Approved By Khajan C. Bhardwaj	Issued By Pourush Garg

5.0 GENERAL CONSTRUCTIONS

The material shall be-

- a) V Cross-arms shall be made out M S Channel 100 x 50 x 6 mm, along with dimensions 100 x 50 x 6 mm at Pole top bracket and 65 x 65 x 6 mm plate welded at both ends, for 33KV, suitable for WPB 13mt, to be used in 33KV. (for details refer attached drawing)
- b) The cross arm shall be hot dipped galvanized generally conforming to IS –2633/72.
- c) The V Cross-arm should not be welded/ jointed at any place except as specified.
- d) The clamps for the V Cross-arm shall be of G.I. & shall be hot dipped galvanized generally conforming to IS – 2633/72.
- e) The clamps shall be designed to fit for the specified rail.
- f) Hot dip galvanizing to be done after fabrication only.
- g) The design shall be suitable for the climatic condition stated above.
- h) The constructional details shall be as per the attached drawing.
- i) Dimensional tolerance shall be limited to 2% except tolerance on thickness until and unless otherwise specified.
- j) Zinc electroplated/painted material will not be accepted
- k) Approximate weight shall be 22kg

6.0 MARKING

The unit shall be appropriately marked as "**PROPERTY OF TPCODL, BHUBANESWAR**" and with the name of the vendor and year of manufacturing at suitable location.

7.0 TESTS

All routine, acceptance & type tests shall be carried out in accordance with the relevant IS/IEC. All routine/acceptance tests shall be witnessed by the purchaser/his authorized representative. All components shall also be type tested as per the relevant standards.

Tests	IS to be referred
Visual test	As a routine test
Dimensional tests	As per the drawing
Tensile strength	IS 2062
Bend test	IS 2062
Impact test	IS 2062
Hot dip galvanizing	IS 4759 : 1996

8.0 TYPE TEST CERTIFICATES

Prepared By Suchismita Nayak	Reviewed By Niranjan Khuntia	Approved By Khajan C. Bhardwaj	Issued By Pourush Garg

 TP CODL TP CENTRAL ODISHA DISTRIBUTION LIMITED	TATA POWER CENTRAL ODISHA DISTRIBUTION LIMITED, ODISHA		
	TECHNICAL SPECIFICATION		
Document Title	Standard Technical Particulars for 33KV V-Cross Arm, Back Clamp & F Clamp(Pole Top Bracket)		
Document No.	ENG-HV-029	Eff. Date: 1.03.2021	
Revision No.	00	Page 4 of 7	
Prepared By Suchismita Nayak	Reviewed By Niranjan Khuntia	Approved By Khajan C. Bhardwaj	Issued By Pourush Garg

The bidder shall furnish the type test certificates of the V Cross Arm for the tests as mentioned above as per the corresponding standards. All the tests shall be conducted at NABL accredited labs as per the relevant standards. Type tests should have been conducted during the period not exceeding 5 years from the date of opening the bid. In the event of any discrepancy in the test reports i.e. any test report not acceptable or any/all type tests (including additional type tests, if any) not carried out, same shall be carried out without any cost implication to TPCODL.

9.0 PRE-DISPATCH INSPECTION

Equipment shall be subjected to inspection by a duly authorized representative of TPCODL. Inspection may be made at any stage of manufacture at the discretion of the purchaser and the equipment, if found unsatisfactory as to workmanship or material, the same is liable to rejection. Bidder shall grant free access to the places of manufacture to TPCODL's representatives at all times when the work is in progress. Inspection by TPCODL or its authorized representatives shall not relieve the bidder of his obligation of furnishing equipment in accordance with the specifications. Material shall be dispatched after specific MDCC (Material Dispatch Clearance Certificate) is issued by TPCODL.

Following documents shall be sent along with material.

- a) Test reports
- b) MDCC issued by TPCODL.
- c) Invoice in duplicate
- d) Packing list
- e) Drawings & catalogue
- f) Guarantee / Warrantee card
- g) Delivery Challan
- h) Other Documents (as applicable)

10.0 INSPECTION AFTER RECEIPT AT STORES

The material received at TPCODL, Bhubaneswar, Odisha store will be inspected for acceptance and shall be liable for rejection, if found different from the reports of the pre-dispatch inspection and one copy of the report shall be sent to Engineering and contracts department.

11.0 GUARANTEE

Bidder shall stand guarantee towards design, materials, workmanship & quality of process / manufacturing of items under this contract for due and intended performance of the same, as an integrated product delivered under this contract. In the event any defect is found by the Company up to a period of at least 12 months from the date of commissioning or 24 months from the date of last supplies made under the contract whichever is later. In the event any defect is found by the Company up to a period of 12 months from the date of commissioning or 24 months from the date of last supplies made under the contract, whichever is earlier, supplier shall be liable to undertake to replace/rectify such defects at his own costs.

Prepared By Suchismita Nayak	Reviewed By Niranjan Khuntia	Approved By Khajan C. Bhardwaj	Issued By Pourush Garg

 TP CENTRAL ODISHA DISTRIBUTION LIMITED	TATA POWER CENTRAL ODISHA DISTRIBUTION LIMITED, ODISHA		
	TECHNICAL SPECIFICATION		
Document Title	Standard Technical Particulars for 33KV V-Cross Arm, Back Clamp & F Clamp(Pole Top Bracket)		
Document No.	ENG-HV-029	Eff. Date: 1.03.2021	
Revision No.	00	Page 5 of 7	
Prepared By Suchismita Nayak	Reviewed By Niranjan Khuntia	Approved By Khajan C. Bhardwaj	Issued By Pourush Garg

12.0 PACKING

Bidder shall ensure that all the equipment covered under this specification shall be prepared for rail/road transport in a manner so as to protect the equipment from damage in transit.

13.0 TENDER SAMPLE

Not required.

14.0 QUALITY CONTROL

The bidder shall submit with the offer Quality assurance plan indicating the various stages of inspection, the tests and checks which will be carried out on the material of construction, components during manufacture and bought out items and fully assembled component and equipment after finishing. As part of the plan, a schedule for stage and final inspection within the parameters of the delivery schedule shall be furnished. TPCODL's engineer or its nominated representative shall have free access to the manufacturer's/sub-supplier's works to carry out inspections.

15.0 MINIMUM TESTING FACILITIES

Bidder shall have adequate in house testing facilities for carrying out all routine tests & acceptance tests as per relevant International / Indian standards

16.0 MANUFACTURING ACTIVITIES

The successful bidder will have to submit the bar chart for various manufacturing activities clearly elaborating each stage, with quantity. This bar chart should be in line with the Quality assurance plan submitted with the offer. This bar chart will have to be submitted within 15 days from the release of the order.

17.0 SPARES, ACCESSORIES AND TOOLS

Bidder shall provide a list of recommended spares with quantity and unit prices for 3 years of operation after commissioning. The bidder shall provide a list of complete set of accessories and tools required for erection & maintenance along with the installation procedure.

18.0 DRAWINGS AND DOCUMENTS

Following drawings & documents shall be prepared based on Purchaser's specifications and statutory requirements with complete BOM and shall be submitted with the bid:

Sl. No.	Description	For Approval	For Review	Final Submission
1	Technical Parameters	✓		✓
2	GA Drawing	✓		✓
3	Installation Instruction			✓
4	Manuals, Catalogues & Drawings		✓	✓

Prepared By Suchismita Nayak	Reviewed By Niranjan Khuntia	Approved By Khajan C. Bhardwaj	Issued By Pourush Garg

 TP CODL TP CENTRAL ODISHA DISTRIBUTION LIMITED	TATA POWER CENTRAL ODISHA DISTRIBUTION LIMITED, ODISHA		
	TECHNICAL SPECIFICATION		
Document Title	Standard Technical Particulars for 33KV V-Cross Arm, Back Clamp & F Clamp(Pole Top Bracket)		
Document No.	ENG-HV-029	Eff. Date: 1.03.2021	
Revision No.	00	Page 6 of 7	
Prepared By Suchismita Nayak	Reviewed By Niranjan Khuntia	Approved By Khajan C. Bhardwaj	Issued By Pourush Garg

5	Dimension drawing		✓	✓
6	QA & QC Plan	✓	✓	✓
7	Routine, Acceptance & Type Test Certificates	✓	✓	✓

- a) General description of the equipment and all components including brochures
- b) General arrangement drawings
- c) Type Test Certificates.
- d) Experience List
- e) Manufacturing schedule and test schedule.

After the contract, four (4) copies of the drawings, drawn to scale, describing the equipment in detail shall be forwarded for approval and shall subsequently provide four (4) complete sets of final drawings, one of which shall be auto positive suitable for reproduction, before the dispatch of the equipment. Soft copy (Compact Disk CD) of all the drawing, test certificates shall be submitted after the final approval of the same to the purchaser.

Following Drawings/Documents shall be submitted after the award of the contract:
Drawings/documents to be submitted after the award of the contract:

19.0 GUARANTEED TECHNICAL PARTICULARS

Sl.no.	Particulars	Bidder's Offer
1	Type of cross arm	
2	Grade of steel	
3	Steel standard	
4	Fabrication standard	
5	Dimensions	
6	Steel section utilized	
7	Steel tensile strength	
8	Working load	
9	Details of Galvanizing methods utilized and Standard/ Specification	
10	Weight of Cross Arm	
11	Whether Drawing has been submitted with the Bid	

Prepared By Suchismita Nayak	Reviewed By Niranjan Khuntia	Approved By Khajan C. Bhardwaj	Issued By Pourush Garg

 TPCODL <small>TP CENTRAL ODISHA DISTRIBUTION LIMITED</small>	TATA POWER CENTRAL ODISHA DISTRIBUTION LIMITED, ODISHA		
	TECHNICAL SPECIFICATION		
Document Title	Standard Technical Particulars for 33KV V-Cross Arm, Back Clamp & F Clamp(Pole Top Bracket)		
Document No.	ENG-HV-029	Eff. Date: 1.03.2021	
Revision No.	00	Page 7 of 7	
Prepared By Suchismita Nayak	Reviewed By Niranjan Khuntia	Approved By Khajan C. Bhardwaj	Issued By Pourush Garg

20.0 SCHEDULE OF DEVIATIONS

All deviations from this specification shall be set out by the bidder, clause by clause in the below mentioned tabular format. Unless specifically mentioned in this schedule, the tender shall be deemed to confirm TPDDL's Specification.

Sl. No.	Clause No.	Details of deviation with justifications

We confirm that there are no deviations apart from those detailed above.

Seal of the Company
Signature
Designation

Prepared By Suchismita Nayak	Reviewed By Niranjan Khuntia	Approved By Khajan C. Bhardwaj	Issued By Pourush Garg

 TP CODL TP CENTRAL ODISHA DISTRIBUTION LIMITED	TATA POWER CENTRAL ODISHA DISTRIBUTION LIMITED, ODISHA		
	TECHNICAL SPECIFICATION		
Document Title	Standard Technical Particulars for 33KV V-Cross Arm, Back Clamp & F Clamp(Pole Top Bracket)		
Document No.	ENG-HV-029	Eff. Date: 1.03.2021	
Revision No.	00	Page 8 of 7	
Prepared By Suchismita Nayak	Reviewed By Niranjan Khuntia	Approved By Khajan C. Bhardwaj	Issued By Pourush Garg

ANNEXURE-1

DRAWING OF V CROSS ARM WITH DETAILED DIMENSIONS

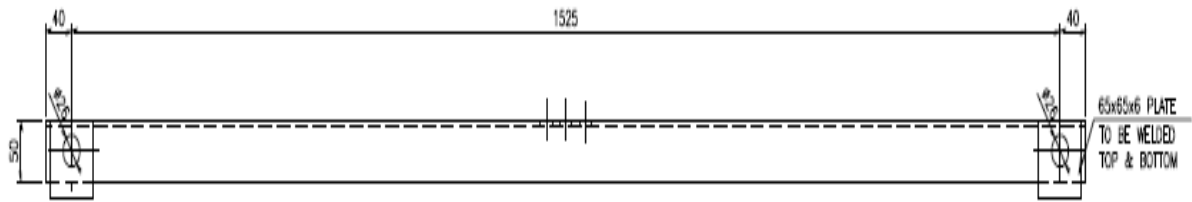

PLAN
V-CROSS ARM(100x50x5)

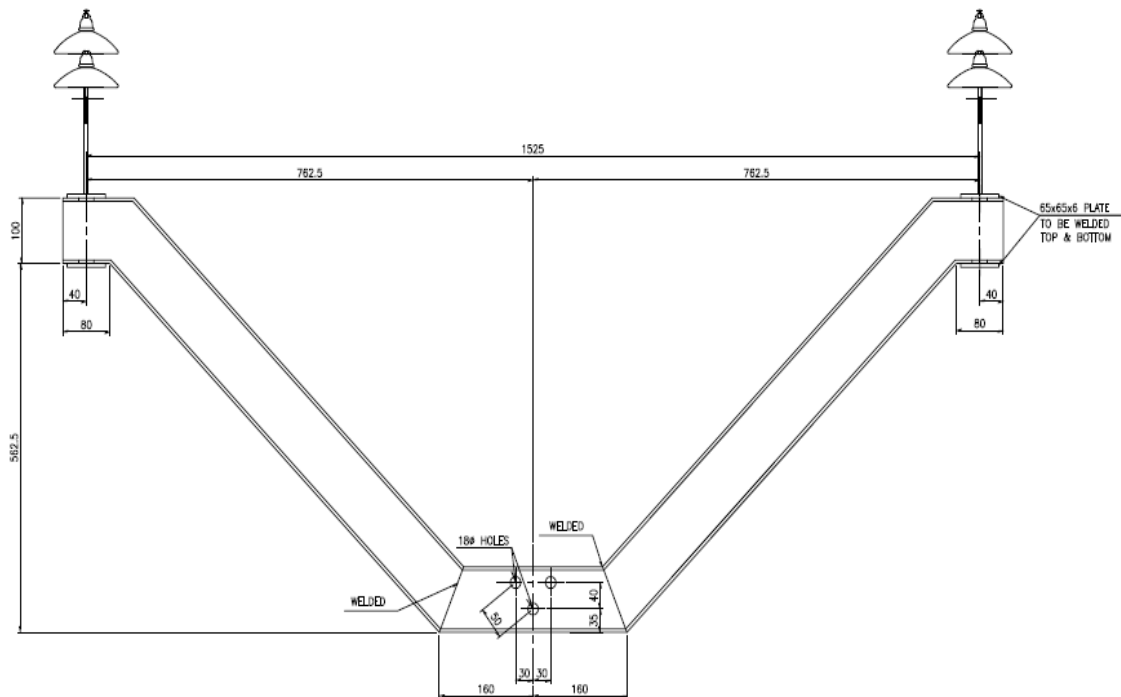

ELEVATION

Prepared By Suchismita Nayak	Reviewed By Niranjan Khuntia	Approved By Khajan C. Bhardwaj	Issued By Pourush Garg
--	--	--	----------------------------------

Document Title	Standard Technical Particulars for 33KV V-Cross Arm, Back Clamp & F Clamp(Pole Top Bracket)		
Document No.	ENG-HV-029	Eff. Date: 1.03.2021	
Revision No.	00	Page 9 of 7	
Prepared By Suchismita Nayak	Reviewed By Niranjan Khuntia	Approved By Khajan C. Bhardwaj	Issued By Pourush Garg

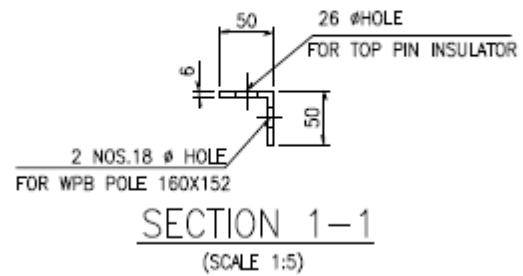
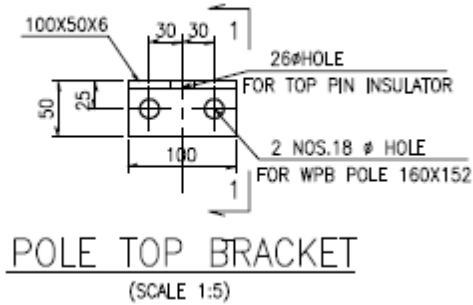

Prepared By Suchismita Nayak	Reviewed By Niranjan Khuntia	Approved By Khajan C. Bhardwaj	Issued By Pourush Garg
--	--	--	----------------------------------